



ASCENTECH®

PRODUCT

CATALOGUE



ASCENTECH

ABOUT US

Ascentech, a DAC certified ISO 9001 & 14001 organization, has been a leading name in LED lighting from 2014. Ascentech is recognized as an R&D house. Ascentech has state-of-the-art testing equipments and conceives, designs and makes LED based products, including all electronics like led PCB's, LED drivers and fixtures. After final assembly, extensive in-house testing is done before supplying products to the market. We, at Ascentech, believe that it is critical for our products to have better illumination ability and energy efficiency and be also 100% fault-free. Therefore, to deliver the best quality products, we have followed a quality management process that adheres to international standards. We are backed by a pool of quality personnel who regularly check the production process to ensure that we leave no loopholes for any kind of fault to occur.

Ascentech vast product range is well accepted by various government, semi-government organizations/institutions and private companies and has received satisfactory performance test certificates from them. Research & Development Ascentech has developed the technology behind LED-lighting systems after investing many man-years in R&D, mastering the technology - electronics and optics. We have an R&D lab having a dedicated facility and team working on new and innovative products for energy conservation. To meet the latest market demands, we are backed by a well equipped manufacturing unit with latest equipment and machines. Based on advanced and sophisticated technology, the different machines installed at our unit are capable of achieving our target production with full accuracy and quality.

COB LIGHTS





COB SWIVEL DOWN LIGHTS

FGDL-05



WATTAGE : 9W
HEIGHT : 45 mm
DIA : 100 mm
COLOUR : 6500K
CUT OUT DIA : 80 mm

FGDL-07



WATTAGE : 15W
HEIGHT : 55 mm
DIA : 115 mm
COLOUR : 6500K
CUT OUT DIA : 95 mm

FGDL-09



WATTAGE : 20W
HEIGHT : 75 mm
DIA : 140 mm
COLOUR : 6500K
CUT OUT DIA : 120 mm

FGDL-10



WATTAGE : 24W
HEIGHT : 75 mm
DIA : 140 mm
COLOUR : 6500K
CUT OUT DIA : 120 mm

FGDL-11



WATTAGE : 30W
HEIGHT : 75 mm
DIA : 160 mm
COLOUR : 6500K
CUT OUT DIA : 140 mm

FGDL-13



WATTAGE : 40W
HEIGHT : 75 mm
DIA : 160 mm
COLOUR : 6500K
CUT OUT DIA : 140 mm



CRI >80



>30,000 Hrs.

Applications : Residential, Small Offices, Service Areas, Retail Shops etc..



COB SPOT DOWN LIGHTS

FGDL-15



WATTAGE : 9W
HEIGHT : 65 mm
DIA : 75 mm
COLOUR : 6500K
CUT OUT DIA : 65 mm

FGDL-17



WATTAGE : 15W
HEIGHT : 80 mm
DIA : 85 mm
COLOUR : 6500K
CUT OUT DIA : 75 mm

FGDL-19



WATTAGE : 20W
HEIGHT : 90 mm
DIA : 95 mm
COLOUR : 6500K
CUT OUT DIA : 85 mm

CONCEALED LIGHT

FGDL-01



WATTAGE : 05W
HEIGHT : 48 mm
DIA : 115 mm
COLOUR : Cool White
CUTOUT DIA : 75 mm
BODY : Aluminium with PC

FGDL-03



WATTAGE : 07W
HEIGHT : 63 mm
DIA : 116 mm
COLOUR : Cool White
CUTOUT DIA : 88 mm
BODY : Aluminium with PC



CRI >80



>30,000 Hrs.

Applications : Residential, Small Offices, Service Areas, Retail Shops etc..



COB TRACK LIGHTS



FGTK-01

WATTAGE : 5W
CCT : 6000K
BODY : Aluminium



FGTK-02

WATTAGE : 10W
CCT : 6000K
BODY : Aluminium



FGTK-03

WATTAGE : 20W
CCT : 6000K
BODY : Aluminium



FGTK-04

WATTAGE : 30W
CCT : 6000K
BODY : Aluminium



CRI >80



>30,000 Hrs.

Applications : Residential, Small Offices, Service Area, Retail Shops etc..



ADJUSTABLE LED SURFACE COB LIGHT

FGTK-06



WATTAGE : 10W
CCT : 6000K
BODY : Aluminium

FGTK-07



WATTAGE : 20W
CCT : 6000K
BODY : Aluminium

COB SURFACE CYLINDER

FGDL-20



WATTAGE : 7W
HEIGHT : 70 mm
DIA : 55 mm
COLOUR : 6500K

FGDL-21



WATTAGE : 12W
HEIGHT : 90 mm
DIA : 70 mm
COLOUR : 6500K

FGDL-22



WATTAGE : 18W
HEIGHT : 100 mm
DIA : 85 mm
COLOUR : 6500K



CRI >80



>30,000 Hrs.

Applications : Residential, Small Offices, Service Area, Retail Shops etc..



WALL LIGHT

FGWL-01

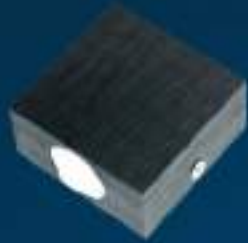

WATTAGE : 3W
 LxBxH : 50x40x35 mm
 CCT : 3000K
 SHAPE : Rectangular
 TYPE : 1 Way

FGWL-02



WATTAGE : 6W
 LxBxH : 50x40x35 mm
 CCT : 3000K
 SHAPE : Rectangular
 TYPE : 2 Way

FGWL-03



WATTAGE : 7W
 LxBxH : 50x90x35 mm
 CCT : 3000K
 SHAPE : Rectangular
 TYPE : 2 Way

FGWL-04



WATTAGE : 6W
 LxBxH : 75x75x35 mm
 CCT : 3000K
 SHAPE : Square
 TYPE : 2 Way

FGWL-05



WATTAGE : 7W
 LxBxH : 70x70x50 mm
 CCT : 3000K
 SHAPE : Square
 TYPE : 2 Way

FGWL-06



WATTAGE : 12W
 LxBxH : 70x70x50 mm
 CCT : 3000K
 SHAPE : Square
 TYPE : 4 Way



CRI >80



>20,000 Hrs.

Applications : Residential, Small Offices, Service Area, Retail Shops etc..



FGWL-07



WATTAGE : 12W
LxBxH : 75x110x40 mm
CCT : 3000K
SHAPE : Rectangular
TYPE : 2 Way



FGWL-08

WATTAGE : 18W
LxBxH : 160x80x45 mm
CCT : 3000K
SHAPE : Rectangular
TYPE : 2 Way

WALL CYLINDER UP-DOWN SPOT LIGHT

FGDL-23



WATTAGE : 12W
HEIGHT : 125 mm
DIA : 80 mm
COLOUR : 6500K



CRI >80



>20,000 Hrs.

Applications : Residential, Small Offices, Service Area, Retail Shops etc..



LED FOOT LIGHT

FGFT-01



WATTAGE : 3W
LxBxH : 100x100x60 mm
COLOUR : 3000K
BODY : Aluminum
CUT OUT SIZE : 90x90 mm

FGFT-02



WATTAGE : 6W
LxBxH : 100x100x60 mm
COLOUR : 3000K
BODY : Aluminum
CUT OUT SIZE : 90x90 mm

FGFT-03



WATTAGE : 12W
LxBxH : 100x100x60 mm
COLOUR : 3000K
BODY : Aluminum
CUT OUT SIZE : 90x90 mm



CRI >80



>20,000 Hrs.

Applications : Residential, Small Offices, Service Area, Retail Shops etc..



BULK HEAD LIGHT



FGBK-02

WATTAGE : 5W
 LxBxH : 167x78x61 mm
 CCT : 6000K
 DIFFUSER : Polycarbonate



FGBK-02

WATTAGE : 10W
 LxBxH : 167x78x61 mm
 CCT : 6000K
 DIFFUSER : Polycarbonate



FGBK-03

WATTAGE : 12W
 LxBxH : 167x78x61 mm
 CCT : 6000K
 DIFFUSER : Polycarbonate



FGBK-03

WATTAGE : 15W
 LxBxH : 167x78x61 mm
 COLOUR : 6000K
 DIFFUSER : Polycarbonate



FGBK-04

WATTAGE : 18W
 LxBxH : 167x78x61 mm
 COLOUR : 6000K
 DIFFUSER : Polycarbonate



FGBK-04

WATTAGE : 20W
 LxBxH : 167x78x61 mm
 COLOUR : 6000K
 DIFFUSER : Polycarbonate



CRI >80



>20,000 Hrs.

Applications : Residential, Small Offices, Service Area, Retail Shops etc..

LED PANEL LIGHTS





LED ULTRA SLIM ROUND PANEL



FGPL-02

WATTAGE	: 6W
HEIGHT	: 31 mm
DIA	: 120 mm
COLOUR	: Cool White
CUT OUT DIA	: 100 mm
BODY	: PC

FGPL-15

WATTAGE	: 6W
HEIGHT	: 31 mm
DIA	: 120 mm
COLOUR	: Warm White
CUT OUT DIA	: 100 mm
BODY	: PC

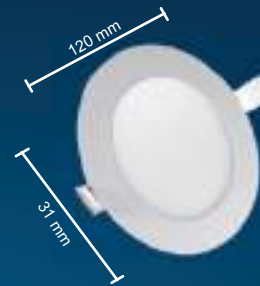

FGPL-03

WATTAGE	: 9W
HEIGHT	: 31 mm
DIA	: 120 mm
COLOUR	: Cool White
CUT OUT DIA	: 100 mm
BODY	: PC

FGPL-16

WATTAGE	: 9W
HEIGHT	: 31 mm
DIA	: 120 mm
COLOUR	: Warm White
CUT OUT DIA	: 100 mm
BODY	: PC



FGPL-04

WATTAGE	: 12W
HEIGHT	: 32 mm
DIA	: 170 mm
COLOUR	: Cool White
CUT OUT DIA	: 150 mm
BODY	: PC

FGPL-17

WATTAGE	: 12W
HEIGHT	: 32 mm
DIA	: 170 mm
COLOUR	: Warm White
CUT OUT DIA	: 150 mm
BODY	: PC



FGPL-05

WATTAGE	: 15W
HEIGHT	: 32 mm
DIA	: 170 mm
COLOUR	: Cool White
CUT OUT DIA	: 150 mm
BODY	: PC

FGPL-18

WATTAGE	: 15W
HEIGHT	: 32 mm
DIA	: 170 mm
COLOUR	: Warm White
CUT OUT DIA	: 150 mm
BODY	: PC



CRI >80



>40,000 Hrs.

Applications : Residential, Small Offices, Service Areas, Retail Shops etc..



LED ULTRA SLIM ROUND PANEL



FGPL-07

WATTAGE	: 20W	20W
HEIGHT	: 32 mm	32 mm
DIA	: 225 mm	225 mm
COLOUR	: Cool White	Warm White
CUT OUT DIA	: 200 mm	200 mm
BODY	: PC	PC

FGPL-20



FGPL-08

WATTAGE	: 24W	24W
HEIGHT	: 32 mm	32 mm
DIA	: 300 mm	300 mm
COLOUR	: Cool White	Warm White
CUT OUT DIA	: 275 mm	275 mm
BODY	: PC	PC

FGPL-21



CRI >80



>40,000 Hrs.

Applications : Residential, Small Offices, Service Areas, Retail Shops etc..



LED ULTRA SLIM SQUARE PANEL

FGPL-28

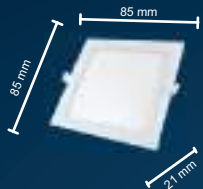

WATTAGE	: 6W	: 6W
LxBxH	: 85x85x21 mm	: 85x85x21 mm
COLOUR	: Cool White	: Warm White
CUT OUT DIA	: 77 mm	: 77 mm
BODY	: PC	: PC

FGPL-47

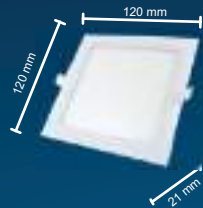

FGPL-29

WATTAGE	: 9W	: 9W
LxBxH	: 120x120x21 mm	: 120x120x21 mm
COLOUR	: Cool White	: Warm White
CUT OUT DIA	: 102 mm	: 102 mm
BODY	: PC	: PC

FGPL-48

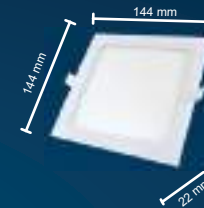

FGPL-30

WATTAGE	: 12W	: 12W
LxBxH	: 144x144x22 mm	: 144x144x22 mm
COLOUR	: Cool White	: Warm White
CUT OUT DIA	: 127 mm	: 127 mm
BODY	: PC	: PC

FGPL-49

FGPL-31

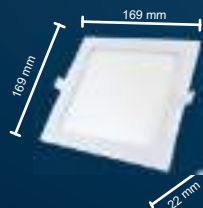

WATTAGE	: 15W	: 15W
LxBxH	: 169x169x22 mm	: 169x169x22 mm
COLOUR	: Cool White	: Warm White
CUT OUT DIA	: 153 mm	: 153 mm
BODY	: PC	: PC

FGPL-50

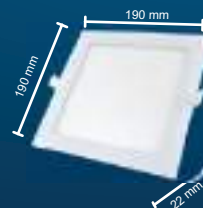

FGPL-32

WATTAGE	: 18W	: 18W
LxBxH	: 190x190x22 mm	: 190x190x22 mm
COLOUR	: Cool White	: Warm White
CUT OUT DIA	: 178 mm	: 178 mm
BODY	: PC	: PC

FGPL-51



CRI >80



>40,000 Hrs.

Applications : Residential, Small Offices, Service Areas, Retail Shops etc..



LED ULTRA SLIM SQUARE PANEL

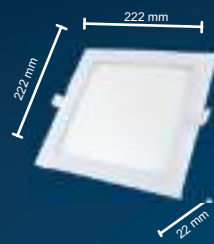

FGPL-34

WATTAGE : 24W
 LxBxH : 222x222x22 mm
 COLOUR : Cool White
 CUT OUT DIA : 203 mm
 BODY : PC

FGPL-53

WATTAGE : 24W
 LxBxH : 222x222x22 mm
 COLOUR : Warm White
 CUT OUT DIA : 203 mm
 BODY : PC

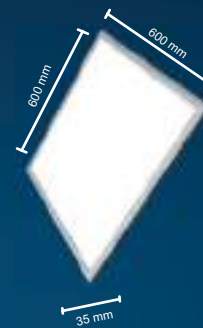

FGPL-35

WATTAGE : 36W
 LxBxH : 600x600x35 mm
 COLOUR : Cool White
 CUT OUT DIA : 585 mm
 BODY : PC

FGPL-54

WATTAGE : 36W
 LxBxH : 600x600x35 mm
 COLOUR : Warm White
 CUT OUT DIA : 585 mm
 BODY : PC

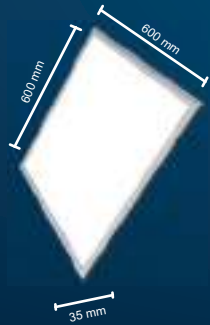

FGPL-36

WATTAGE : 40W
 LxBxH : 600x600x35 mm
 COLOUR : Cool White
 CUT OUT DIA : 585 mm
 BODY : PC

FGPL-55

WATTAGE : 40W
 LxBxH : 600x600x35 mm
 COLOUR : Warm White
 CUT OUT DIA : 585 mm
 BODY : PC



FGPL-37

WATTAGE : 48W
 LxBxH : 600x600x35 mm
 COLOUR : Cool White
 CUT OUT DIA : 585 mm
 BODY : PC

FGPL-56

WATTAGE : 48W
 LxBxH : 600x600x35 mm
 COLOUR : Warm White
 CUT OUT DIA : 585 mm
 BODY : PC



CRI >80



>40,000 Hrs.

Applications : Residential, Small Offices, Service Areas, Retail Shops etc..



LED ULTRA SURFACE SQUARE PANEL

FGPL-38

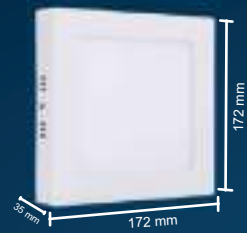

	FGPL-38	FGPL-49
WATTAGE	12W	12W
LxBxH	172x172x35 mm	172x172x35 mm
COLOUR	Cool White	Warm White
BODY	PC	PC

FGPL-49

FGPL-39

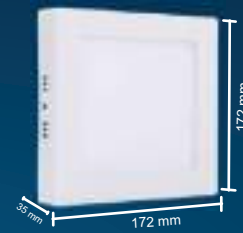

	FGPL-39	FGPL-50
WATTAGE	15W	15W
HEIGHT	172x172x35 mm	172x172x35 mm
COLOUR	Cool White	Warm White
BODY	PC	PC

FGPL-50

FGPL-40

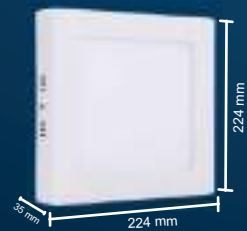

	FGPL-40	FGPL-51
WATTAGE	18W	18W
HEIGHT	224x224x35 mm	224x224x35 mm
COLOUR	Cool White	Warm White
BODY	PC	PC

FGPL-51

FGPL-41

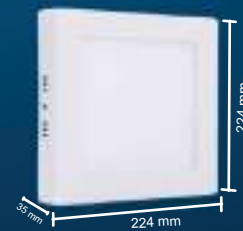

	FGPL-41	FGPL-52
WATTAGE	20W	20W
HEIGHT	224x224x35 mm	224x224x35 mm
COLOUR	Cool White	Warm White
BODY	PC	PC

FGPL-52



CRI >80



>40,000 Hrs.

Applications : Residential, Small Offices, Service Areas, Retail Shops etc..



LED ULTRA SURFACE SQUARE PANEL

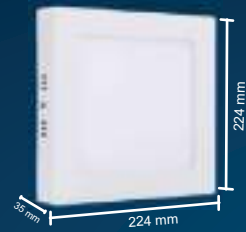

FGPL-42

WATTAGE : 24W
LxBxH : 224x224x35 mm
COLOUR : Cool White
BODY : PC

FGPL-53

WATTAGE : 24W
LxBxH : 224x224x35 mm
COLOUR : Warm White
BODY : PC

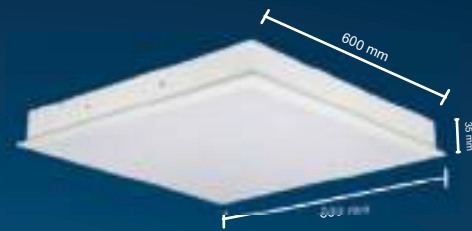

FGPL-43

WATTAGE : 36W
HEIGHT : 600x600x35 mm
COLOUR : Cool White
BODY : PC

FGPL-54

WATTAGE : 36W
HEIGHT : 600x600x35 mm
COLOUR : Warm White
BODY : PC

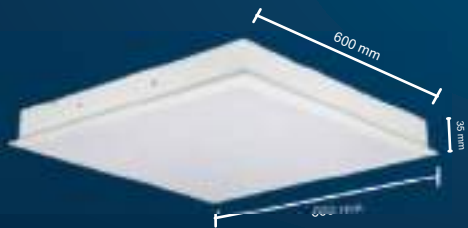

FGPL-44

WATTAGE : 40W
HEIGHT : 600x600x35 mm
COLOUR : Cool White
BODY : PC

FGPL-55

WATTAGE : 40W
HEIGHT : 600x600x35 mm
COLOUR : Warm White
BODY : PC



FGPL-45

WATTAGE : 48W
HEIGHT : 600x600x35 mm
COLOUR : Cool White
BODY : PC

FGPL-56

WATTAGE : 48W
HEIGHT : 600x600x35 mm
COLOUR : Warm White
BODY : PC



CRI >80



>40,000 Hrs.

Applications : Residential, Small Offices, Service Areas, Retail Shops etc..



LED ULTRA SURFACE ROUND PANEL



FGPL-09		FGPL-22	
WATTAGE	: 12W	: 12W	
HEIGHT	: 35 mm	: 35 mm	
DIA	: 177 mm	: 177 mm	
COLOUR	: Cool White	: Warm White	
BODY	: PC	: PC	



FGPL-10		FGPL-23	
WATTAGE	: 15W	: 15W	
HEIGHT	: 35 mm	: 35 mm	
DIA	: 225 mm	: 225 mm	
COLOUR	: Cool White	: Warm White	
BODY	: PC	: PC	



FGPL-11		FGPL-24	
WATTAGE	: 18W	: 18W	
HEIGHT	: 35 mm	: 35 mm	
DIA	: 225 mm	: 225 mm	
COLOUR	: Cool White	: Warm White	
BODY	: PC	: PC	



FGPL-13		FGPL-26	
WATTAGE	: 24W	: 24W	
HEIGHT	: 35 mm	: 35 mm	
DIA	: 300 mm	: 300 mm	
COLOUR	: Cool White	: Warm White	
BODY	: PC	: PC	



CRI >80



>40,000 Hrs.

Applications : Residential, Small Offices, Service Areas, Retail Shops etc..



LED DEEP ANTI GLARE SQUARE PANEL LIGHT



FGPL-71

WATTAGE : 12W
 LxBxH : 115x105x105 mm
 COLOUR : 6500K
 BODY : Aluminium



FGPL-73

WATTAGE : 18W
 LxBxH : 150x135x135 mm
 COLOUR : 6500K
 BODY : Aluminium



FGPL-75

WATTAGE : 24W
 LxBxH : 170x160x160 mm
 COLOUR : 6500K
 BODY : Aluminium

LED DEEP ANTI GLARE ROUND PANEL LIGHT



FGPL-70

WATTAGE : 12W
 HEIGHT : 50 mm
 DIA : 120 mm
 COLOUR : 6500K
 CUT OUT DIA : 115 mm
 BODY : Aluminium



FGPL-72

WATTAGE : 18W
 HEIGHT : 50 mm
 DIA : 155 mm
 COLOUR : 6500K
 CUT OUT DIA : 150 mm
 BODY : Aluminium



FGPL-74

WATTAGE : 24W
 HEIGHT : 50 mm
 DIA : 175 mm
 COLOUR : 6500K
 CUT OUT DIA : 170 mm
 BODY : Aluminium



CRI >80



>40,000 Hrs.

Applications : Residential, Small Offices, Service Areas, Retail Shops etc..

LED ULTRA SLIM ROUND PANEL LIGHT

FGPL-76



WATTAGE : 4W
 HEIGHT : 16 mm
 DIA : 80 mm
 COLOUR : 6500K
 BODY : Aluminum
 CUT OUT DIA : 70 mm

FGPL-77



WATTAGE : 15W
 HEIGHT : 16 mm
 DIA : 165 mm
 COLOUR : 6500K
 BODY : Aluminum
 CUT OUT DIA : 155 mm

FGPL-78



WATTAGE : 22W
 HEIGHT : 16 mm
 DIA : 215 mm
 COLOUR : 6500K
 BODY : Aluminum
 CUT OUT DIA : 200 mm

LED ULTRA SLIM SQUARE PANEL LIGHT

FGPL-81



WATTAGE : 4W
 LxBxH : 84x84x15 mm
 COLOUR : 6500K
 BODY : Aluminum
 CUT OUT SIZE : 70x70 mm

FGPL-82



WATTAGE : 15W
 LxBxH : 162x162x15 mm
 COLOUR : 6500K
 BODY : Aluminum
 CUT OUT SIZE : 150x150 mm

FGPL-83



WATTAGE : 22W
 LxBxH : 215x215x15 mm
 COLOUR : 6500K
 BODY : Aluminum
 CUT OUT SIZE : 200x200 mm



CRI >80



>40,000 Hrs.

Applications : Residential, Small Offices, Service Areas, Retail Shops etc..



LED ULTRA SURFACE ROUND PANEL LIGHT

FGPL-79



WATTAGE : 15W
 HEIGHT : 32 mm
 DIA : 168 mm
 COLOUR : 6500K
 BODY : Aluminum

FGPL-80



WATTAGE : 18W
 HEIGHT : 32 mm
 DIA : 215 mm
 COLOUR : 6500K
 BODY : Aluminum

LED ULTRA SURFACE SQUARE PANEL LIGHT

FGPL-84



WATTAGE : 12W
 LxBxH : 115x115x32 mm
 COLOUR : 6500K
 BODY : Aluminum

FGPL-85



WATTAGE : 18W
 LxBxH : 165x165x32 mm
 COLOUR : 6500K
 BODY : Aluminum

FGPL-86



WATTAGE : 24W
 LxBxH : 215x215x32 mm
 COLOUR : 6500K
 BODY : Aluminum



CRI >80



>40,000 Hrs.

Applications : Residential, Small Offices, Service Areas, Retail Shops etc..



LED STRIKER SLIM SURFACE LIGHT

FGPL-68



WATTAGE	: 5W
HEIGHT	: 15 mm
DIA	: 68 mm
COLOUR	: 6000K
BODY	: Polycarbonate

FULL GLOW SURFACE STRIKER LIGHT

FGPL-69



WATTAGE	: 5W
HEIGHT	: 18 mm
DIA	: 65 mm
COLOUR	: 6000K
BODY	: Polycarbonate



CRI >80



>40,000 Hrs.

Applications : Residential, Small Offices, Service Area, Retail Shops etc..

LED BULBS





LED BULBS

RMLB-03

RMLB-05

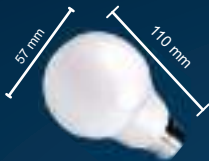

WATTAGE	: 7W	7W
HEIGHT	: 110 mm	110 mm
LxB	: 57 mm	57 mm
CAP TYPE	: B22	B22
CCT	: 6000K	3000K

RMLB-03

RMLB-05

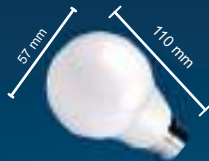

WATTAGE	: 9W	9W
HEIGHT	: 110 mm	110 mm
LxB	: 57 mm	57 mm
CAP TYPE	: B22	B22
CCT	: 6000K	3000K

RMLB-01

RMLB-11

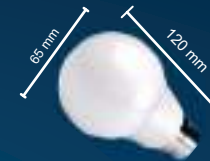

WATTAGE	: 12W	12W
HEIGHT	: 120 mm	120 mm
LxB	: 65 mm	65 mm
CAP TYPE	: B22	B22
CCT	: 6000K	3000K

RMLB-01

RMLB-11

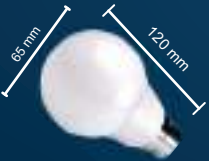

WATTAGE	: 15W	15W
HEIGHT	: 120 mm	120 mm
LxB	: 65 mm	65 mm
CAP TYPE	: B22	B22
CCT	: 6000K	3000K

RMLB-04

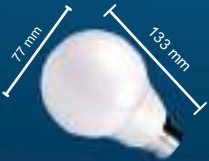

WATTAGE	: 20W
HEIGHT	: 133 mm
LxB	: 77 mm
CAP TYPE	: B22
CCT	: 6000K

RMLB-06

RMLB-06

RMLB-06

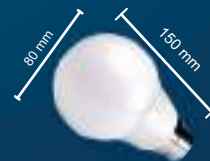

WATTAGE	: 22W	24W	25W
HEIGHT	: 150 mm	150 mm	150 mm
LxB	: 80 mm	80 mm	80 mm
CAP TYPE	: B22	B22	B22
CCT	: 6000K	6000K	6000K



CRI >80



>45,000 Hrs.

Applications : Residential, Small Offices, Service Areas, Retail Shops etc..



RMLB-19

WATTAGE : 30W
LxBxH : 103x103x192 mm
CCT : 6000K
CAP TYPE : B22



RMLB-20

WATTAGE : 40W
LxBxH : 117x117x215 mm
CCT : 6000K
CAP TYPE : B22



RMLB-20

WATTAGE : 50W
LxBxH : 117x117x215 mm
CCT : 6000K
CAP TYPE : B22



RMLB-16

WATTAGE : 10W
LxBxH : 106x200x30 mm
CCT : 6000K
CAP TYPE : B22



RMLB-17

WATTAGE : 15W
LxBxH : 106x230x30 mm
CCT : 6000K
CAP TYPE : B22



RMLB-18

WATTAGE : 20W
LxBxH : 106x280x30 mm
CCT : 6000K
CAP TYPE : B22



CRI >80



>45,000 Hrs.

Applications : Residential, Small Offices, Service Areas, Retail Shops etc..



LED INVERTER BULBS



	RMLB-14	RMLB-02
WATTAGE	9W	9W
HEIGHT	110 mm	110 mm
DIA	57 mm	57 mm
CCT	6000K	3000K
CAP TYPE	B22	B22
BACKUP	4 Hrs.	4 Hrs.



	RMLB-14	RMLB-02
WATTAGE	12W	12W
HEIGHT	110 mm	110 mm
DIA	57 mm	57 mm
CCT	6000K	3000K
CAP TYPE	B22	B22
BACKUP	4 Hrs.	4 Hrs.



CRI >80



>45,000 Hrs.

Applications : Residential, Small Offices, Service Areas, Retail Shops etc..



NIGHT LAMPS

FGNL-01

WATTAGE	: 0.5W
HEIGHT	: 68 mm
DIA	: 48 mm
BODY	: Polycarbonate

FGNL-02

WATTAGE	: 0.5W
HEIGHT	: 68 mm
DIA	: 48 mm
BODY	: Polycarbonate

FGNL-03

WATTAGE	: 0.5W
HEIGHT	: 68 mm
DIA	: 48 mm
BODY	: Polycarbonate

FGNL-04

WATTAGE	: 0.5W
HEIGHT	: 68 mm
DIA	: 48 mm
BODY	: Polycarbonate

FGNL-05

WATTAGE	: 0.5W
HEIGHT	: 68 mm
DIA	: 48 mm
BODY	: Polycarbonate

FGNL-06

WATTAGE	: 0.5W
HEIGHT	: 68 mm
DIA	: 48 mm
BODY	: Polycarbonate



CRI >80



>35,000 Hrs.

Applications : Residential, Small Offices, Service Areas, Retail Shops etc..



TUBE LIGHTS

FGTL-21



WATTAGE	: 5W
LxBxH	: 305x20x40 mm
BODY	: ABS
MODEL	: T5
CCT	: 6500K

FGTL-05



WATTAGE	: 10W
LxBxH	: 610x20x40 mm
BODY	: ABS
MODEL	: T5
CCT	: 6500K

FGTL-06



WATTAGE	: 12W	12W
LxBxH	: 610x20x40 mm	1200x120 mm
BODY	: ABS	ABS
MODEL	: T5	T8
CCT	: 6500K	6500K

FGTL-12

FGTL-02



WATTAGE	: 18W	18W
LxBxH	: 1130x20x40 mm	1200x120 mm
BODY	: ABS	ABS
MODEL	: T5	T8
CCT	: 6500K	6500K

FGTL-08



FGTL-01

WATTAGE	: 20W	20W
LxBxH	: 1170x20x40 mm	1200x120 mm
BODY	: ABS	ABS
MODEL	: T5	T8
CCT	: 6500K	6500K

FGTL-09



FGTL-15

WATTAGE	: 22W	22W
LxBxH	: 1170x20x40 mm	1200x120 mm
BODY	: ABS	ABS
MODEL	: T5	T8
CCT	: 6500K	6500K

FGTL-16



CRI >80



>25,000 Hrs.

Applications : Residential, Small Offices, Service Areas, Retail Shops etc..



FGTL-20



WATTAGE	: 24W	36W
LxBxH	: 1170x20x40 mm	1170x20x40 mm
BODY	: ABS	ABS
MODEL	: T5	T5
CCT	: 6500K	6500K

FGTL-19



FGTL-19

WATTAGE	: 40W	72W
LxBxH	: 1170x20x40 mm	1170x20x40 mm
BODY	: ABS	ABS
MODEL	: T5	T5
CCT	: 6500K	6500K

FGTL-18

INVERTER TUBE LIGHT

FGTL-13



WATTAGE	: 20W
LxBxH	: 1170x20x40 mm
BODY	: ABS
MODEL	: T5
CCT	: 6500K
BACKUP	: 3 Hrs.

FGTL-22



WATTAGE	: 10W
LxBxH	: 590x20x40 mm
BODY	: ABS
MODEL	: T5
CCT	: 6500K
BACKUP	: 3 Hrs.



CRI >80



>25,000 Hrs.

Applications : Residential, Small Offices, Service Areas, Retail Shops etc..



LED ROPE LIGHT

FGRL-01

FGRL-02



LED	: 2835	2835
WATTAGE	: 6W/Mtr.	6W/Mtr.
LENGTH	: 50 Mtr.	50 Mtr.
MODEL	: Pipe Type	Pipe Type

FGRL-03

FGRL-04



LED	: 5050	5050
WATTAGE	: 6W/Mtr.	6W/Mtr.
LENGTH	: 50 Mtr.	50 Mtr.
MODEL	: Pipe Type	Pipe Type

FGRL-05

FGRL-06



LED	: 2825	2835
WATTAGE	: 8W/Mtr.	8W/Mtr.
LENGTH	: 50 Mtr.	50 Mtr.
MODEL	: Neon Strip	Neon Strip

FGRL-07

FGRL-08



LED	: 5050	5050
WATTAGE	: 8W/Mtr.	8W/Mtr.
LENGTH	: 50 Mtr.	50 Mtr.
MODEL	: Neon Strip	Neon Strip

FGRL-09

FGRL-10



LED	: 2835	2835
WATTAGE	: 5W/Mtr.	5W/Mtr.
LENGTH	: 5 Mtr.	5 Mtr.
MODEL	: Strip Type	Strip Type

FGRL-11

FGRL-12



LED	: 5050	5050
WATTAGE	: 5W/Mtr.	5W/Mtr.
LENGTH	: 5 Mtr.	5 Mtr.
MODEL	: Strip Type	Strip Type



CRI >80



>25,000 Hrs.



COLOUR TEMP.
Red, Green, Blue, Yellow, Orange

Applications : Residential, Small Offices, Service Areas, Retail Shops etc..



COB Grille Light

6W - COB Grille Light



MaterialSize : 115 x 22 x 25 mm (LxWxH)
Light Source : Osram LED
LED CCT : 3000k, 4000k
Body Color : Black
Voltage : AC 220V, DC 48V
Housing : Matt Black
Material : Aluminum Alloy

12w - COB Grille Light



MaterialSize : 223 x 22 x 25 mm (LxWxH)
Light Source : Osram LED
LED CCT : 3000k, 4000k
Body Color : Black
Voltage : AC 220V, DC 48V
Housing : Matt Black
Material : Aluminum Alloy

18w - COB Grille Light



MaterialSize : 331 x 22 x 25 mm (LxWxH)
Light Source : Osram LED
LED CCT : 3000k, 4000k
Body Color : Black
Voltage : AC 220V, DC 48V
Housing : Matt Black
Material : Aluminum Alloy

24W - COB Grille Light



MaterialSize : 439 x 22 x 25 mm (LxWxH)
Light Source : Osram LED
LED CCT : 3000k, 4000k
Body Color : Black
Voltage : AC 220V, DC 48V
Housing : Matt Black
Material : Aluminum Alloy

30w - COB Grille Light



MaterialSize : 547 x 22 x 25 mm (LxWxH)
Light Source : Osram LED
LED CCT : 3000k, 4000k
Body Color : Black
Voltage : AC 220V, DC 48V
Housing : Matt Black
Material : Aluminum Alloy



CRI >80



>35,000 Hrs.

Applications : Residential, Small Offices, Service Areas, Retail Shops etc..



COB Track Light

30W - COB Track Light



MaterialSize : 48 x 105 mm
Light Source : Osram LED
LED CCT : 3000k, 4000k
Body Color : Black
Voltage : AC 220V, DC 48V
Housing : Matt Black
Material : Aluminum Alloy

6W - COB Magnetic Pendant



MaterialSize : 30 x 300 mm
Light Source : Osram LED
LED CCT : 3000k, 4000k
Body Color : Black
Voltage : AC 220V, DC 48V
Housing : Matt Black
Material : Aluminum Alloy

12W - COB Magnetic Pendant



MaterialSize : 60 x 300 mm
Light Source : Osram LED
LED CCT : 3000k, 4000k
Body Color : Black
Voltage : AC 220V, DC 48V
Housing : Matt Black
Material : Aluminum Alloy



CRI >80



>35,000 Hrs.

Applications : Residential, Small Offices, Service Areas, Retail Shops etc..

LED OUTDOOR LIGHTS





GM MODEL FLOOD LIGHT

FGFL-106



WATTAGE	: 30W	50W	60W
LxBxH	: 175x175x40 mm	220x230x50 mm	220x230x50 mm
CCT	: 6000K	6000K	6000K
Lumen/W	: 100lm/w	100lm/w	100lm/w
Input Voltage	: 90-300V	90-300V	90-300V
PF	: 0.95	0.95	0.95

FGFL-91

FGFL-91



FGFL-90

FGFL-90

WATTAGE	: 100W	120W
LxBxH	: 220x230x45 mm	220x230x45 mm
CCT	: 6000K	6000K
Lumen/W	: 100lm/w	100lm/w
Input Voltage	: 90-300V	90-300V
PF	: 0.95	0.95

FGFL-98



FGFL-97

WATTAGE	: 200W	240W
LxBxH	: 335x315x60 mm	335x315x60 mm
CCT	: 6000K	6000K
Lumen/W	: 100lm/w	100lm/w
Input Voltage	: 90-300V	90-300V
PF	: 0.95	0.95



CRI >80



>50,000 Hrs.

Applications : Stadium, Park, Street, Resident etc..



GM MODEL FLOOD LIGHT



FGFL-94

FGFL-37

FGFL-39

FGFL-41

WATTAGE :	300W	350W	400W	500W
LxBxH :	380x370x60 mm	380x370x60 mm	380x370x60 mm	460x495x60 mm
CCT :	6000K	6000K	6000K	6000K
Lumen/W :	100lm/w	100lm/w	100lm/w	100lm/w
Input Voltage :	90-300V	90-300V	90-300V	90-300V
PF :	0.95	0.95	0.95	0.95



FGFL-107

FGFL-107

FGFL-108

FGFL-84

FGFL-84

WATTAGE :	600W	700W	750W	900W	1050W
LxBxH :	350x480x140 mm	350x480x140 mm	350x480x140 mm	390x510x160 mm	390x510x160 mm
CCT :	6000K	6000K	6000K	6000K	6000K
Lumen/W :	100lm/w	100lm/w	100lm/w	100lm/w	100lm/w
Input Voltage :	90-300V	90-300V	90-300V	90-300V	90-300V
PF :	0.95	0.95	0.95	0.95	0.95



CRI >80



>50,000 Hrs.

Applications : Stadium, Park, Street, Resident etc..



LED RGB FLOOD LIGHT



FGFL-111

FGFL-76

FGFL-110

WATTAGE	: 50W	100W	120W
LxBxH	: 220x230x50 mm	220x230x50 mm	220x230x50 mm
CCT	: 6000K	6000K	6000K
Lumen/W	: 100lm/w	100lm/w	100lm/w
Input Voltage	: 90-300V	90-300V	90-300V
PF	: 0.95	0.95	0.95

CANOPY FLOOD LIGHT



FGFL-79

FGFL-75

WATTAGE	: 80W	100W
LxBxH	: 375x375x100 mm	375x375x100 mm
CCT	: 6000K	6000K
Lumen/W	: 100lm/w	100lm/w
Input Voltage	: 90-300V	90-300V
PF	: 0.95	0.95



CRI >80



>50,000 Hrs.

Applications : Stadium, Park, Street, Resident etc..



LM MODEL FLOOD LIGHT



FGFL-57

FGFL-57

FGFL-59

FGFL-59

FGFL-66

FGFL-66

FGFL-60

FGFL-60

FGFL-61

WATTAGE	: 15W	18W	24W	25W	32W	36W	45W	50W	60W
LxBxH	: 200x150x38 mm	200x150x38 mm	200x150x38 mm	200x150x38 mm	200x150x38 mm	200x150x38 mm	200x150x38 mm	200x150x38 mm	200x150x38 mm
CCT	: 6000K	6000K	6000K	6000K	6000K	6000K	6000K	6000K	6000K
Lumen/W	: 100lm/w	100lm/w	100lm/w	100lm/w	100lm/w	100lm/w	100lm/w	100lm/w	100lm/w
Input Voltage	: 90-300V	90-300V	90-300V	90-300V	90-300V	90-300V	90-300V	90-300V	90-300V
PF	: 0.95	0.95	0.95	0.95	0.95	0.95	0.95	0.95	0.95



FGFL-103

FGFL-65

FGFL-65

FGFL-72

FGFL-72

FGFL-67

WATTAGE	: 70W	90W	100W	110W	120W	150W
LxBxH	: 220x230x45 mm	220x230x45 mm	220x230x45 mm	220x230x45 mm	220x230x45 mm	220x230x45 mm
CCT	: 6000K	6000K	6000K	6000K	6000K	6000K
Lumen/W	: 100lm/w	100lm/w	100lm/w	100lm/w	100lm/w	100lm/w
Input Voltage	: 90-300V	90-300V	90-300V	90-300V	90-300V	90-300V
PF	: 0.95	0.95	0.95	0.95	0.95	0.95



CRI >80



>50,000 Hrs.

Applications : Stadium, Park, Street, Resident etc..



LED LM STREET LIGHT

FGSL-66

FGSL-66

FGSL-67

FGSL-63

FGSL-61

WATTAGE :	25W	30W	40W	45W	50W
LxBxH :	210x120x60 mm	210x120x60 mm	210x120x60 mm	210x120x60 mm	210x120x60 mm
CCT :	6000K	6000K	6000K	6000K	6000K
Lumen/W :	100lm/w	100lm/w	100lm/w	100lm/w	100lm/w
Input Voltage :	90-300V	90-300V	90-300V	90-300V	90-300V
DIA ID :	Flexible	Flexible	Flexible	Flexible	Flexible

FGSL-96

FGSL-96

FGSL-96

WATTAGE :	70W	90W	100W
LxBxH :	210x120x60 mm	210x120x60 mm	210x120x60 mm
CCT :	6000K	6000K	6000K
Lumen/W :	100lm/w	100lm/w	100lm/w
Input Voltage :	90-300V	90-300V	90-300V
DIA ID :	68	68	68



CRI >80



>50,000 Hrs.

Applications : Stadium, Park, Street, Resident etc..



LED GM STREET LIGHT



FGSL-53	FGSL-53	FGSL-53	FGSL-22	FGSL-33	FGSL-33	FGSL-34	FGSL-34	FGSL-34	FGSL-87
WATTAGE : 15W	18W	24W	25W	36W	40W	45W	48W	50W	60W
LxBxH : 305x95x50 mm	305x95x50 mm	305x95x50 mm	305x95x50 mm	305x95x50 mm	305x95x50 mm	305x95x50 mm	305x95x50 mm	305x95x50 mm	305x95x50 mm
CCT : 6000K	6000K	6000K	6000K	6000K	6000K	6000K	6000K	6000K	6000K
Lumen/W : 100lm/w	100lm/w	100lm/w	100lm/w	100lm/w	100lm/w	100lm/w	100lm/w	100lm/w	100lm/w
Input Voltage : 90-300V	90-300V	90-300V	90-300V	90-300V	90-300V	90-300V	90-300V	90-300V	90-300V
DIA ID : 39	39	39	39	39	39	39	39	39	39



FGSL-48
WATTAGE : 70W
LxBxH : 305x95x60 mm
CCT : 6000K
Lumen/W : 100lm/w
Input Voltage : 90-300V
DIA ID : 47



FGSL-42	FGSL-42	FGSL-41	FGSL-41
WATTAGE : 90W	100W	110W	120W
LxBxH : 320x145x60 mm	320x145x60 mm	320x145x60 mm	320x145x60 mm
CCT : 6000K	6000K	6000K	6000K
Lumen/W : 100lm/w	100lm/w	100lm/w	100lm/w
Input Voltage : 90-300V	90-300V	90-300V	90-300V
DIA ID : 52	52	52	52



CRI >80



>50,000 Hrs.

Applications : Stadium, Park, Street, Resident etc..



LED HIGHBAY LIGHT



FGHB-17

WATTAGE : 50W
 CCT : 6000K
 Height : 170 mm
 Fixture Dia : 215 mm

FGHB-17

80W
 6000K
 170 mm
 215 mm



FGHB-18

WATTAGE : 100W
 CCT : 6000K
 Height : 170 mm
 Fixture Dia : 215 mm

FGHB-18

120W
 6000K
 170 mm
 215 mm



FGHB-04

WATTAGE : 130W
 CCT : 6000K
 Height : 170 mm
 Fixture Dia : 215 mm

FGHB-04

140W
 6000K
 170 mm
 215 mm

FGHB-04

150W
 6000K
 170 mm
 215 mm

FGHB-06

180W
 6000K
 170 mm
 215 mm

FGHB-06

200W
 6000K
 170 mm
 215 mm



FGHB-15

WATTAGE : 240W
 CCT : 6000K
 Height : 170 mm
 Fixture Dia : 215 mm

FGHB-15

250W
 6000K
 230 mm
 255 mm

FGHB-13

300W
 6000K
 230 mm
 255 mm

FGHB-16

400W
 6000K
 230 mm
 255 mm



CRI >80



>50,000 Hrs.

Applications : Manufacturing Plant, Factory, Power Sheds, etc..



UNDERWATER LIGHT

FGUW-03



WATTAGE : 9W
Height : 46 mm
Upper Dia : 95 mm
Lumen/W : 100lm/w
Input Voltage : 90-300V

FGUW-01



WATTAGE : 18W
Height : 46 mm
Upper Dia : 125 mm
Lumen/W : 100lm/w
Input Voltage : 90-300V

FGUW-03



WATTAGE : 36W
Height : 80 mm
Upper Dia : 160 mm
Lumen/W : 100lm/w
Input Voltage : 90-300V

FGUW-07



WATTAGE : 36W
Height : 80 mm
Upper Dia : 160 mm
Lumen/W : 100lm/w
Input Voltage : 90-300V



CRI >80



>50,000 Hrs.

Applications : Swimming Pools, Water Parks, Fountains etc..



FLAMEPROOF FLOOD LIGHT



	FGFP-01	FGFP-02	FGFP-02	FGFP-03	FGFP-04
WATTAGE	40W	45W	50W	60W	70W
CCT	6000K	6000K	6000K	6000K	6000K
Height	240 mm	240 mm	240 mm	240 mm	240 mm
Fixture Dia	300 mm	300 mm	300 mm	300 mm	300 mm



	FGFP-08	FGFP-09
WATTAGE	150W	200W
CCT	6000K	6000K
Height	290 mm	290 mm
Fixture Dia	600 mm	600 mm



	FGFP-06	FGFP-06	FGFP-07
WATTAGE	80W	100W	120W
CCT	6000K	6000K	6000K
Height	240 mm	240 mm	240 mm
Fixture Dia	300 mm	300 mm	300 mm



CRI >80



>50,000 Hrs.

Applications : Coal Fields, Industrial Sector, Petroleum Plant etc..



WELL GLASS LIGHT



	FGWG-06	FGWG-06	FGWG-01	FGWG-02	FGWG-03	FGWG-15	FGWG-11	FGWG-04	FGWG-10
WATTAGE :	25W	30W	35W	40W	42W	50W	60W	70W	75W
HEIGHT :	110 mm	110 mm	110 mm	110 mm	110 mm	110 mm	110 mm	110 mm	150 mm
DIA :	130 mm	130 mm	130 mm	130 mm	130 mm	130 mm	130 mm	130 mm	200 mm
CCT :	6000K	6000K	6000K	6000K	6000K	6000K	6000K	6000K	6000K
Input Voltage :	90-300V	90-300V	90-300V	90-300V	90-300V	90-300V	90-300V	90-300V	90-300V
DIFFUSER :	PC	PC	PC	PC	PC	PC	PC	PC	PC



CRI >80



>50,000 Hrs.

Applications : Coal Fields, Petroleum Plants, etc..



EXIT LIGHTS



FGEL-24

WATTAGE	: 10W	10W
LxBxH	: 300x130x30 mm	300x130x30 mm
COLOUR	: GREEN	GREEN

FGEL-43



FGEL-25

WATTAGE	: 20W
LxBxH	: 300x130x30 mm
COLOUR	: GREEN



FGEL-03

WATTAGE	: 40W
LxBxH	: 300x200x300 mm
COLOUR	: Red + Warm White



CRI >80



>50,000 Hrs.

Applications : Airports, Hotels, Malls, Metro, Railway Station etc..



SPIKE LIGHTS



FGSP-04

WATTAGE	: 5W	5W	5W	5W
HEIGHT	: 250 mm	250 mm	250 mm	250 mm
UPPER DIA	: 60 mm	60 mm	60 mm	60 mm
LOWER DIA	: 5 mm	5 mm	5 mm	5 mm
COLOUR	: RED	BLUE	GREEN	WARM WHITE



FGSP-03

FGSP-08

WATTAGE	: 10W	10W
HEIGHT	: 280 mm	280 mm
UPPER DIA	: 75 mm	75 mm
LOWER DIA	: 8 mm	8 mm
COLOUR	: WARM WHITE	COOL WHITE



FGSP-01

WATTAGE	: 15W
HEIGHT	: 280 mm
UPPER DIA	: 75 mm
LOWER DIA	: 8 mm
COLOUR	: WARM WHITE



CRI >80



>30,000 Hrs.

Applications : Garden, Park, Residential, Nursery, etc..



WALL WASHER LIGHT



FGWW-01

FGWW-01

WATTAGE	: 36W	40W
LxBxH	: 120x80x80 mm	120x80x80 mm
PF	: 0.95	0.95
Lumen/W	: 100lm/w	100lm/w
Input Voltage	: 90-300V	90-300V

PAR LIGHTS

FGDJ-08

FGDJ-09



WATTAGE	: 100W	100W
HEIGHT	: 300 mm	300 mm
DIA	: 300 mm	300 mm
COLOUR	: Multi Colour	Multi Colour



FGDJ-08

FGDJ-09

WATTAGE	: 150W	150W
HEIGHT	: 300 mm	300 mm
DIA	: 300 mm	300 mm
COLOUR	: Multi Colour	Multi Colour



CRI >80



>30,000 Hrs.

Applications : Garden, Park, Residential, Nursery, etc..

BOLLARD LIGHT





FGBL-10

WATTAGE : 15W
 HEIGHT : 610 mm
 L X B : 110 x 110 mm
 CCT : 3000K
 MATERIAL : Aluminium



FGBL-06

WATTAGE : 15W
 HEIGHT : 1000 - 1500 mm
 DIA : 600 x 88 mm
 CCT : 3000K - 6000K
 MATERIAL : Aluminium

FGBL-04

18W
 HEIGHT : 1000 - 1500 mm
 DIA : 600 x 88 mm
 CCT : 3000K - 6000K
 MATERIAL : Aluminium



FGBL-09

WATTAGE : 20W
 HEIGHT : 1000 mm
 DIA : 88 mm
 COLOUR : 3000K - 6000K
 MATERIAL : Aluminium



FGBL-01

WATTAGE : 10W | 15W
 HEIGHT : 610 - 914 mm | 610 - 914 mm
 DIA : 88 mm | 88 mm
 CCT : 3000k - 6000K | 3000K - 6000K
 MATERIAL : Aluminium | Aluminium

FGBL-02



FGBL-07

WATTAGE : 10W
 HEIGHT : 610 mm
 DIA : 110 mm
 CCT : 3000K - 6000K
 MATERIAL : Aluminium



FGBL-08

WATTAGE : 20W
 HEIGHT : 610 - 914 - 1000 mm
 DIA : 88 mm
 CCT : 3000K - 6000K
 MATERIAL : Aluminium



CRI >80



>35,000 Hrs.

Applications : Parks, Gardens, Residents, etc..

POST TOP LIGHT





FGPT-01



FGPT-05

WATTAGE : 20W	20W
HEIGHT : 370 mm	370 mm
UPPER DIA : 900 mm	900 mm
LOWER DIA : 100 mm	100 mm
POLE OD : 75 mm	75 mm
CCT : 6000K	6000K
DIFFUSER : Clear	Milky

FGPT-02



FGPT-06

WATTAGE : 40W	40W
HEIGHT : 370 mm	370 mm
UPPER DIA : 900 mm	900 mm
LOWER DIA : 100 mm	100 mm
POLE OD : 75 mm	75 mm
CCT : 6000K	6000K
DIFFUSER : Clear	Milky

FGPT-03



FGPT-07

WATTAGE : 45W	45W
HEIGHT : 370 mm	370 mm
UPPER DIA : 1100 mm	1100 mm
LOWER DIA : 150 mm	150 mm
POLE OD : 70 mm	70 mm
CCT : 6000K	6000K
DIFFUSER : Clear	Milky

FGPT-04



FGPT-08

WATTAGE : 60W	60W
HEIGHT : 370 mm	370 mm
UPPER DIA : 1100 mm	1100 mm
LOWER DIA : 150 mm	150 mm
POLE OD : 70 mm	70 mm
CCT : 6000K	6000K
DIFFUSER : Clear	Milky



CRI >80



>25,000 Hrs.

Applications : Parks, Gardens, Residents, etc..

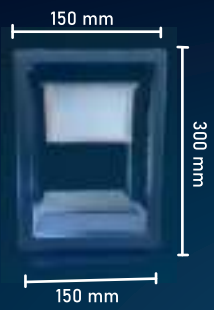

FGPT-11

WATTAGE : 15W
LxBxH : 150x150x300 mm
COLOUR : Cool White
BODY : Aluminium



FGPT-09

WATTAGE : 15W
LxBxH : 150x150x300 mm
COLOUR : Warm White
BODY : Aluminium



FGPT-10

WATTAGE : 25W
HEIGHT : 400 mm
UPPER DIA : 900 mm
LOWER DIA : 85 mm
POLE OD : 85 mm
COLOUR : Cool White



CRI >80

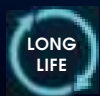

>25,000 Hrs.

Applications : Parks, Gardens, Residents, etc..



PORTABLE EMERGENCY LIGHTING SYSTEM TOWER TYPE AC GENSET

FGEL-26

1 KVA

FGEL-41

2 KVA

FGEL-39

3 KVA

Rating Of Generator Set (In KVA)	: 1 KVA
Number Of Cylinder In The Engine	: 1
Minimum Continuous Working Hours	: 5Hour
Gen Set Fuel Tank Capacity (Minimum) - In Litres	: 3.5
Type Of Fuel	: Petrol
Minimum System Lumens	: 50000
Material Of Tower	: Galvanised Iron/Mild steel
Minimum Height Of Tower:	: 4M
Type Of Mounting	: With trolley

Rating Of Generator Set (In KVA)	: 2 KVA
Number Of Cylinder In The Engine	: 1
Minimum Continuous Working Hours	: 12 Hour
Gen Set Fuel Tank Capacity (Minimum) - In Litres	: 9.5
Type Of Fuel	: Petrol
Minimum System Lumens	: 60000-80000
Material Of Tower	: Galvanised Iron/Mild steel
Minimum Height Of Tower:	: 4M
Type Of Mounting	: With trolley

Rating Of Generator Set (In KVA)	: 3 KVA
Number Of Cylinder In The Engine	: 1
Minimum Continuous Working Hours	: 12 - 18 Hour
Gen Set Fuel Tank Capacity (Minimum) - In Litres	: 20
Type Of Fuel	: Petrol
Minimum System Lumens	: 60000 - 80000
Material Of Tower	: Galvanised Iron/Mild steel
Minimum Height Of Tower:	: 4M
Type Of Mounting	: With trolley



Applications : Construction Sites, Gardens, Coal Fields, etc..



PORTABLE EMERGENCY LIGHTING SYSTEM TOWER TYPE AC GENSET

FGEL-27

5 KVA

Rating Of Generator Set (In KVA)	: 5 KVA
Number Of Cylinder In The Engine	: 1
Minimum Continuous Working Hours	: 12 - 30 Hour
Gen Set Fuel Tank Capacity (Minimum) - In Litres	: 15 - 25
Type Of Fuel	: Diesel
Minimum System Lumens	: 80000 - 150000
Material Of Tower	: Galvanised Iron/Mild steel
Minimum Height Of Tower:	: 7-9M
Type Of Mounting	: With trolley



FGEL-28

7.5 KVA

Rating Of Generator Set (In KVA)	: 7.5 KVA
Number Of Cylinder In The Engine	: 2
Minimum Continuous Working Hours	: 12 - 30 Hour
Gen Set Fuel Tank Capacity (Minimum) - In Litres	: 15 - 40
Type Of Fuel	: Diesel
Minimum System Lumens	: 80000-150000
Material Of Tower	: Galvanised Iron/Mild steel
Minimum Height Of Tower:	: 7-9M
Type Of Mounting	: With trolley



Applications : Construction Sites, Gardens, Coal Fields, etc..



REMOTE AREA LIGHTING SYSTEM

FGEL-07

SINGLE POLE

FGEL-34

DOUBLE POLE

FGEL-33

FOUR POLE

Minimum System Lumen	:	5000
Minimum Continuous Working Hours	:	15 Hours
Chemistry Of Battery	:	Li-ion
Battery Voltage	:	12V
Battery Capacity	:	60AH
Minimum Height Of Tower	:	> 2 Mtr.
Material Of Tower	:	Aluminum
Protection Of The Entire Housing	:	IP66
Operating Temperature Range	:	-20 deg. C to +50 deg. C

Minimum System Lumen	:	5000*2
Minimum Continuous Working Hours	:	8 - 15 Hours
Chemistry Of Battery	:	Li-ion
Battery Voltage	:	12V
Battery Capacity	:	60AH - 90AH
Minimum Height Of Tower	:	>2 Mtr.
Material Of Tower	:	Aluminum
Protection Of The Entire Housing	:	IP66
Operating Temperature Range	:	-20 deg. C to +50 deg. C

Minimum System Lumen	:	5000*4
Minimum Continuous Working Hours	:	8 Hours
Chemistry Of Battery	:	Li-ion
Battery Voltage	:	12V
Battery Capacity	:	93AH
Minimum Height Of Tower	:	>2 Mtr.
Material Of Tower	:	Aluminum
Protection Of The Entire Housing	:	IP66
Operating Temperature Range	:	-20 deg. C to +50 deg. C



Applications : Construction Sites, Gardens, Coal Fields, etc..



FGEL-20

EMERGENCY LIGHT WITH TRIPOD STAND



Body Material	: ALUMINIUM
Power	: 80 - 400 W
HEIGHT	: 3 Mtr.
Lightening Color	: Cool White
Lighting Type	: High Intensity Discharge LED
IP Rating	: IP 66
Working Voltage	: 90 - 300VAC, 50 - 60Hz
Features	: Easy Installation on concrete roof Used for Searching
Beam Range	: 400+ Metres
PF	: >0.95
Rotate	: 360°
CCT	: 5500K-6000K
CRI	: >70
EFFICACY	: 100 lm/W
Optical Grade	: Reflector / Lens
Narrow Beam	: 10° - 20°
Reflector/Lens Efficiency	: >90%



FGEL-47

FLOOD LIGHT WITH TRIPOD STAND

Body Material	: ALUMINIUM
Power	: 80 - 400 W
HEIGHT	: 3 Mtr.
Lightening Color	: Cool White
Lighting Type	: High Intensity Discharge LED
IP Rating	: IP 66
Working Voltage	: 90 - 300VAC, 50 - 60Hz
Features	: Easy Installation on concrete roof Used for Searching
Beam Range	: 400+ Metres
PF	: >0.95
Rotate	: 360°
CCT	: 5500K-6000K
CRI	: >70
EFFICACY	: 100 lm/W
Optical Grade	: Reflector / Lens
Narrow Beam	: 10° - 20°
Reflector/Lens Efficiency	: >90%

Applications : Construction Sites, Gardens, Coal Fields, etc..

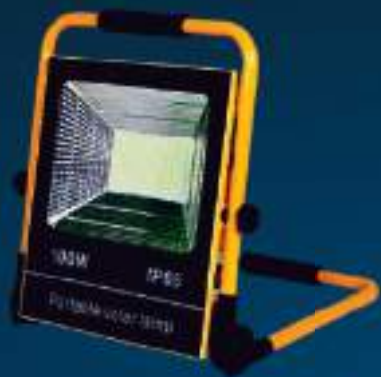

100W Rechargeable Flood Light



Magnetic Rechargeable Flood Light

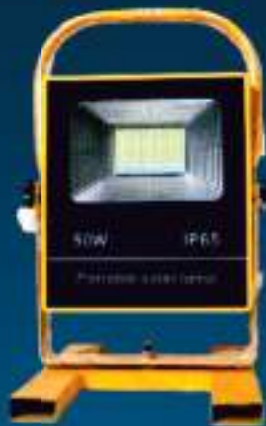

Tripod Rechargeable Flood Light



50W Rechargeable Flood Light

Rechargeable Flood Light

Brand	: Ascentech
Color	: White, Cool White 6500k
Material	: Aluminium
Style	: Modern
Light Fixture Form	: Floodlight
Room Type	: Any
Specific Uses for Product	: Both Indoor and Outdoor
Power Source	: Battery Powered
Installation Type	: Portable Freestanding Light
Special Feature	: Cordless
Control Method	: Remote
Light Source Type	: LED
Finish Type	: Powder Coated
Shade Material	: Toughened Glass
No. of Light Source	: 1
Voltage	: 5 Volts (DC)
Light Color	: Milky White
Lighting Method	: Adjustable

Applications : Construction Sites, Gardens, Coal Fields, etc..



FGEL-38

FIELD MOTORIZED REVOLVING SEARCH LIGHT

Body Material	:	ALUMINIUM
Power	:	250 - 300W
Lightening Colour	:	Cool White
Lighting Type	:	High Intensity Discharge LED
IP Rating	:	IP 66
Working Voltage	:	90 - 300VAC, 50 - 60Hz
Features	:	High Narrow Beam, Protection from High/Low Volts
Beam Range	:	500 - 600 Metres
PF	:	>0.95
Horizontal Rotation	:	360°
Vertical Tilting	:	Upto 45°
Rotation Speed	:	01-10 RPM
CCT	:	5500K-6000K
Optical Grade	:	Reflector/Lens
Reflector/Lens Efficiency	:	>90%

(With Control Panel and Remote)



FGEL-17

VEHICLE MOUNTED REVOLVING SEARCH LIGHT

LED	:	50W (5w x 10)
Operating Voltage	:	12V DC (With DC/ Car Cigarette Lighter Socket)
Operating Options	:	Through Wireless remote control with Left, Right, Up & Down functions
Colour/Material	:	Black/Polycarbonate
Beam Distance	:	Upto 500m Approx in clear weather
Lift time in Hours	:	50,000 hour (Approx)
Rotation	:	Horizontal 360° & Vertical 90°
Base	:	Heavy Magnet base for stability
Weight	:	Around 4 Kgs (w/o battery)
Dimension	:	26 x 20.5 x 18 cms
Handle	:	Provided on the Top

Applications : Construction Sites, Gardens, Coal Fields, etc..

**FGEL-19****HIGHBAY MOTORIZED REVOLVING LIGHT**

Body Material	:	ALUMINIUM
Power	:	80 – 400 W
Lightening Color	:	Cool White
Lighting Type	:	High Intensity Discharge LED
IP Rating	:	IP 66
Working Voltage	:	90 – 300VAC, 50 – 60Hz
Features	:	Easy Installation on concrete roof Used for Searching
Beam Range	:	400+ Metres
PF	:	>0.95
Rotate	:	360°
Rotation Speed	:	02 RPM
CCT	:	5500K-6000K
Optical Grade	:	Reflector / Lens
Narrow Beam	:	10° – 20°
Reflector/Lens Efficiency	:	>90%

FGEL-18**HIGHBAY MANUAL REVOLVING LIGHT**

Body Material	:	ALUMINIUM
Power	:	80 – 400 W
Lightening Color	:	Cool White
Lighting Type	:	High Intensity Discharge LED
IP Rating	:	IP 66
Working Voltage	:	90 – 300VAC, 50 – 60Hz
Features	:	Easy Installation on concrete roof Used for Searching
Beam Range	:	400+ Metres
PF	:	>0.95
Rotate	:	360°
Rotation Speed	:	02 RPM
CCT	:	5500K-6000K
Optical Grade	:	Reflector / Lens
Narrow Beam	:	10° – 20°
Reflector/Lens Efficiency	:	>90%



HIGHBAY LIGHT WITH TRIPOD STAND



FGEL-21

Body Material	:	ALUMINIUM
Power	:	250W
Lightening Color	:	Cool White
Lighting Type	:	High Intensity Discharge LED
IP Rating	:	IP 66
Working Voltage	:	90-300VAC, 50-60Hz
Features	:	High Narrow Beam, Protection from High/Low Volts
Beam Range	:	400+ Meters
PF	:	>0.95
Rotate	:	360°
Minimum height of Tower	:	3M
CCT	:	5500K-6000K
Optical Grade	:	Reect or/Lens
Narrow Beam	:	10° - 20°
Reflector/Lens Efficiency	:	>90%

Applications : Construction Sites, Gardens, Coal Fields, etc..



500 Mtr. Range Revolving Search Light



FGEL-21

Body Material	:	ALUMINIUM
Power	:	250 - 300W
Lightening Color	:	Cool White
Lighting Type	:	High Intensity Discharge LED
IP Rating	:	IP 66
Working Voltage	:	90-300VAC, 50-60Hz
Features	:	High Narrow Beam, Protection from High/Low Volts
Beam Range	:	500+ Meters
PF	:	>0.95
Rotate	:	360°
Height of Tower	:	4M
CCT	:	5500K-6000K
Optical Grade	:	Reect or/Lens
Narrow Beam	:	10° - 20°
Reflector/Lens Efficiency	:	>90%

Applications : Construction Sites, Gardens, Coal Fields, etc..



HELIPAD LIGHT

FGHP-02



Light Source	:	Ultra High Intensity LED
No. of LEDs	:	4 LEDs (2 White LEDs & 2 RGB LEDs)
Input Charging Voltage	:	220 V AC, 50 Hz
CRI (Ra)	:	> 70 (For white LEDs)
Height	:	12 Inch
Length	:	8 Inch
Width	:	8 Inch
Weight	:	4.5 Kg
Body Color	:	Yellow
Body Material	:	Mild Steel
Operation Mode	:	30 Hours
Operating Voltage	:	5V DC
Horizontal Output	:	360 degree
No. of Modes of Light	:	Four Modes (White Light, Blue Light, Green Light, Red Light)
Flash Characteristics	:	Instant Burning
Wind Speed (m/s)	:	225
Humidity	:	10-90 %
LED Life Hours (Minimum)	:	50000 Hours
IP Rating	:	Ip67
Ambient Temperature	:	-20 to 55 degree C
Circuit Protection	:	Integrated

Applications : Helipad, Grounds, etc..

TORCH & BATON



HAND HELD SEARCH LIGHT

FGHH-36



Type of lamp	:	LED
Battery capacity (AH)	:	8 AH
Wattage of lamp (Watt)	:	55 W
Type of battery	:	Lithium-ion/SMF
Type of housing material	:	ABS
Warranty for HHSL (in years)	:	12 Months
Lamp life (Hours)	:	50000
Run time(Hours)	:	6 Hours
Battery Voltage (Volts)	:	3.7V
Dia of search light (mm)	:	140 mm
Lamp dimming	:	Step type
Effective distance of search light	:	>800 meters

FGHH-05



Type of lamp	:	LED
Battery capacity (AH)	:	8 AH
Wattage of lamp (Watt)	:	30 W
Type of battery	:	Lithium-ion/SMF
Type of housing material	:	ABS
Warranty for HHSL (in years)	:	12 Months
Lamp life (Hours)	:	50000
Run time(Hours)	:	6 Hours
Battery Voltage (Volts)	:	3.7V
Dia of search light (mm)	:	115 mm
Lamp dimming	:	Step type
Effective distance of search light	:	>600 meters

FGHH-21



Type of lamp	:	LED
Battery capacity (AH)	:	4-5 AH
Wattage of lamp (Watt)	:	25 W
Type of battery	:	Lithium-ion/SMF
Type of housing material	:	ABS
Warranty for HHSL (in years)	:	12 Months
Lamp life (Hours)	:	50000
Run time(Hours)	:	6 Hours
Battery Voltage (Volts)	:	3.7V
Dia of search light (mm)	:	125-150 mm
Lamp dimming	:	Step type

FGHH-35



Type of lamp	:	LED
Battery capacity (AH)	:	9 AH
Wattage of lamp (Watt)	:	50 W
Type of battery	:	Lithium-ion/SMF
Type of housing material	:	ABS
Warranty for HHSL (in years)	:	12 Months
Lamp life (Hours)	:	50000
Run time(Hours)	:	6 Hours
Battery Voltage (Volts)	:	3.7V
Dia of search light (mm)	:	125-150 mm
Lamp dimming	:	Step type

HAND HELD SEARCH LIGHT

FGHH-14



Type of lamp	:	LED
Battery capacity (AH)	:	8 AH
Wattage of lamp (Watt)	:	20 W
Type of battery	:	Lithium-ion/SMF
Type of housing material	:	ABS
Warranty for HHSL (in years)	:	12 Months
Lamp life (Hours)	:	50000
Run time(Hours)	:	2 Hours
Battery Voltage (Volts)	:	3.7V
Dia of search light (mm)	:	100-125 mm
Lamp dimming	:	Step type
Effective distance of search light	:	500 meters

FGHH-05



Type of lamp	:	LED
Battery capacity (AH)	:	4-5 AH
Wattage of lamp (Watt)	:	10 W
Type of battery	:	Lithium-ion/SMF
Type of housing material	:	ABS
Warranty for HHSL (in years)	:	12 Months
Lamp life (Hours)	:	50000
Run time(Hours)	:	5 Hours
Battery Voltage (Volts)	:	4.2 V
Dia of search light (mm)	:	105 mm
Lamp dimming	:	Step type
Effective distance of search light	:	400 meters

FGHH-46



Type of lamp	:	LED
Battery capacity (AH)	:	5 AH
Wattage of lamp (Watt)	:	15 W
Type of battery	:	Lithium-ion/SMF
Type of housing material	:	ABS
Warranty for HHSL (in years)	:	12 Months
Lamp life (Hours)	:	50000
Run time(Hours)	:	5.5 Hours
Battery Voltage (Volts)	:	3.7 V
Dia of search light (mm)	:	76-100 mm
Lamp dimming	:	Step type

FGHH-20



Type of lamp	:	LED
Battery capacity (AH)	:	8 AH
Wattage of lamp (Watt)	:	25 W
Type of battery	:	Lithium-ion/SMF
Type of housing material	:	ABS
Warranty for HHSL (in years)	:	12 Months
Lamp life (Hours)	:	50000
Run time(Hours)	:	6 Hours
Battery Voltage (Volts)	:	3.7 - 4.2 V
Dia of search light (mm)	:	101-125 mm
Lamp dimming	:	Step type

HAND HELD SEARCH LIGHT

FGHH-54

Type of lamp	: LED
Dia of search light (mm)	: 50 to 75
Wattage of lamp (Watt)	: 30
Color temperature (Degree K)	: 4000 to 4500 deg. K for other lamps
Type of battery	: Lithium ion
Type of housing material	: Aluminium
Warranty for HHSL (in years)	: 12 Months (Li-ion battery)
Continuous search light operation time at maximum lumen output (Hours)	: FOR LED/XENON \geq 3 HRS
Beam angle selection	: Wide
Lamp dimming	: Continuous
Effective distance of search light	: \geq 100 metres
Type of front glass	: Toughened, scratch resistant
Operation mode	: High Beam/ Low Beam
Gross weight of Search light with battery (Kg) and Ingress protection	: 1.8 kg (max.,) with Li-ion battery
Accessories required	: Recharging Adapter For Both Dc And Ac/ Shoulder Strap



FGHH-29

Type of lamp	: LED
Dia of search light (mm)	: 50 to 75
Wattage of lamp (Watt)	: 20
Color temperature (Degree K)	: 5500 to 6500 deg. K for other lamps
IP Rating	: IP-66
Beam angle selection	: Narrow and Wide (both feature)
Built-in battery charger	: No but external
Type of battery	: Lithium ion
Type of housing material	: Aluminium
Gross weight	: 1.8 kg (max.,) with Li-ion battery
Warranty for HHSL (in years)	: 12 Months (Li-ion battery)
Lamp dimming	: Step type
lumen output (Hours)	: FOR LED/XENON \geq 2 HRS
Operating Temperature range	: -20 deg C to +55 deg C
Operating Range	: $>$ 500 meter
charging time	: 4Hrs
Lamp life	: 50000hrs



HAND HELD SEARCH LIGHT

FGHH-13

Type of lamp	:	LED
Dia of search light (mm)	:	126 to 150
Wattage of lamp (Watt)	:	10
Color temperature (Degree K)	:	5500 to 6500 deg. K for other lamps
IP Rating	:	IP-66
Beam angle selection	:	Narrow
Built-in battery charger	:	Yes
Type of battery	:	Lithium ion
Type of housing material	:	Aluminium
Gross weight	:	1.8 kg (max.,) with Li-ion battery
Warranty for HHSL (in years)	:	12 Months (Li-ion battery)
Lamp dimming	:	Step type
lumen output (Hours)	:	FOR LED/XENON >/= 5 HRS
Operating Temperature range	:	-10 deg C to +55 deg C
Operating Range	:	>500 meter
charging time	:	4Hrs
Lamp life	:	50000hrs



FGHH-45

Type of lamp	:	LED
Dia of search light (mm)	:	130 to 160
Wattage of lamp (Watt)	:	55
Color temperature (Degree K)	:	5500 to 6500 deg. K for other lamps
IP Rating	:	IP-66
Beam angle selection	:	Narrow and Wide (both feature)
Built-in battery charger	:	No but external
Type of battery	:	Lithium ion
Type of housing material	:	Aluminium
Gross weight	:	4 Kg with Li-ion battery
Warranty for HHSL (in years)	:	12 Months (Li-ion battery)
Lamp dimming	:	Step type
lumen output (Hours)	:	FOR LED/XENON >/= 2 HRS
Operating Temperature range	:	-20 deg C to +55 deg C
Operating Range	:	>500 meter
charging time	:	4Hrs
Lamp life	:	50000hrs



HAND HELD SEARCH LIGHT

FGHH-61

Type of lamp	: LED
Dia of search light (mm)	: 50 to 75
Wattage of lamp (Watt)	: 10
Color temperature (Degree K)	: 5500 to 6500 deg. K for other lamps
Type of battery	: Lithium ion
Type of housing material	: Aluminium
Warranty for HHSL (in years)	: 12 Months (Li-ion battery)
lumen output (Hours)	: FOR LED/XENON >/= 5 HRS
Beam angle selection	: Narrow
Built-in battery charger	: NO but external
Battery Voltage (Volts)	: 3.7
Light output of search light	: 1000
Effective distance of search light	: >/= 400 metres



FGHD-14

Material	: Aluminium Alloy + ABS
LED Light Source	: T6/XPE LED
Net Weight	: 200g
Mode	: High - LOW - Strobe
Battery	: 1800 mAh / Built in Lithium Battery
Charging Method	: Type - C USB
Sensor Distance	: 10 cm
Runtime	: 4 - 6 Hours
Function	: Power Display / Power Bank
Switch	: Press Switch + Long Power Bank
Zoomable Lense	: Telescopic Zoomable Lense



SHOCK BATON & TRAFFIC BATON



FGHH-74

Weight	: 01 Kg (Maximum)
Carriage	: Hand Held
Body Material	: ABS
Operating Temperature	: -20 to 50 degree C
Indicators	: Full, Low & Charging Battery
Input Voltage	: 220 Volt, 50Hz
Output Voltage	: Minimum 10 KV
Activation of Shock	: By Self-Return Trigger Switch



FGHH-63

Weight	: 01 Kg (Maximum)
Carriage	: Hand Held
Body Material	: ABS
Operating Voltage	: 3.7 V DC
Indicators	: Full, Low & Charging Battery
Input Voltage	: 220 Volt, 50Hz
Colour	: Red, Green, White
Extra Features	: Light on Top and Buzzer



FGHH-44

Type of lamp	: LED
Dia of search light (mm)	: 50 to 75
Wattage of lamp (Watt)	: 10
Color temperature (Degree K)	: 5500 to 6500 deg. K for other lamps
Type of battery	: Lithium ion
Type of housing material	: Aluminium
Warranty for HHSL (in years)	: 12 Months (Li-ion battery)
lumen output (Hours)	: FOR LED/XENON >= 5 HRS
Beam angle selection	: Narrow
Built-in battery charger	: NO but external
Battery Voltage (Volts)	: 3.7
Light output of search light	: 1000
Effective distance of search light	: >= 400 metres



FGHH-39

Type of lamp	: LED
Dia of search light (mm)	: 130 to 160
Wattage of lamp (Watt)	: 40
Color temperature (Degree K)	: 5500 to 6500 deg. K for other lamps
IP Rating	: IP-66
Beam angle selection	: Narrow and Wide (both feature)
Built-in battery charger	: No but external
Type of battery	: Lithium ion
Type of housing material	: Aluminium
Gross weight	: 2.5 Kg with Li-ion battery
Warranty for HHSL (in years)	: 12 Months (Li-ion battery)
Lamp dimming	: Step type
lumen output (Hours)	: FOR LED/XENON >= 2 HRS
Operating Temperature range	: -20 deg C to +55 deg C
Operating Range	: >500 meter
charging time	: 4Hrs
Lamp life	: 50000hrs



ASCENTECH[®]

CONTACT US:-

Ascentech Lightning Solution
Email - ascentechled@gmail.com
Phone No. +91 81303 88587
Website :- www.ascentech.in

GET IN TOUCH



Scan for Website



@Ascentech

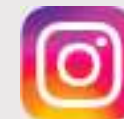

@ascentechofficial



@Ascentech



AT-200

Deployable portable lighting in one bespoke robust package.

Portable
Tripod
Light





HUMANIZED DESIGN HIDDEN IN THE DETAILS

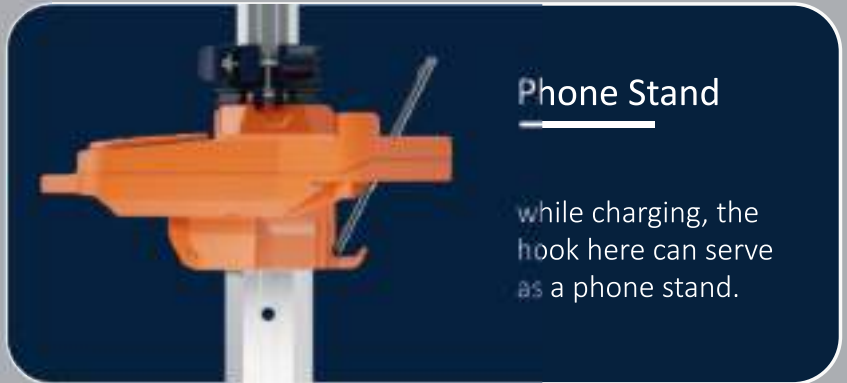
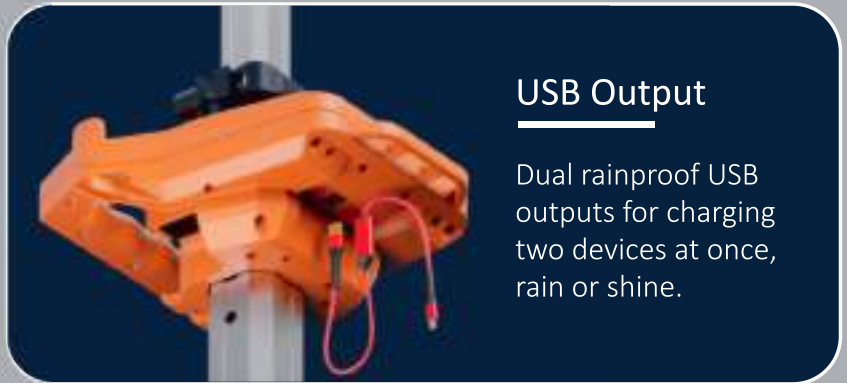
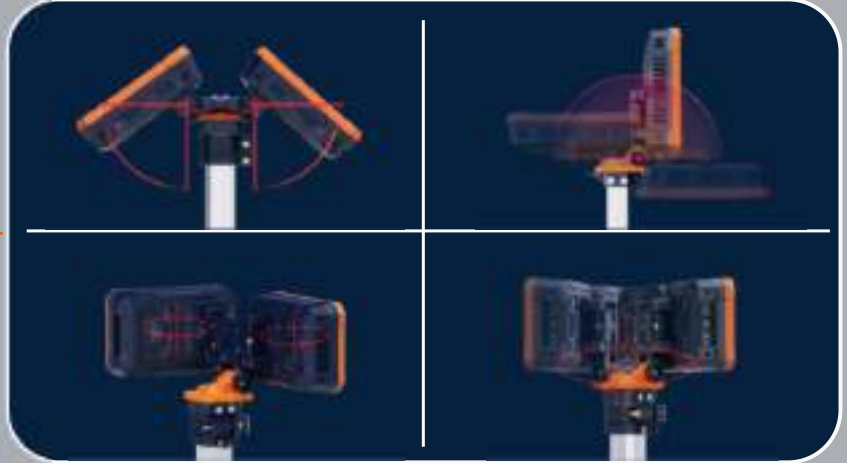
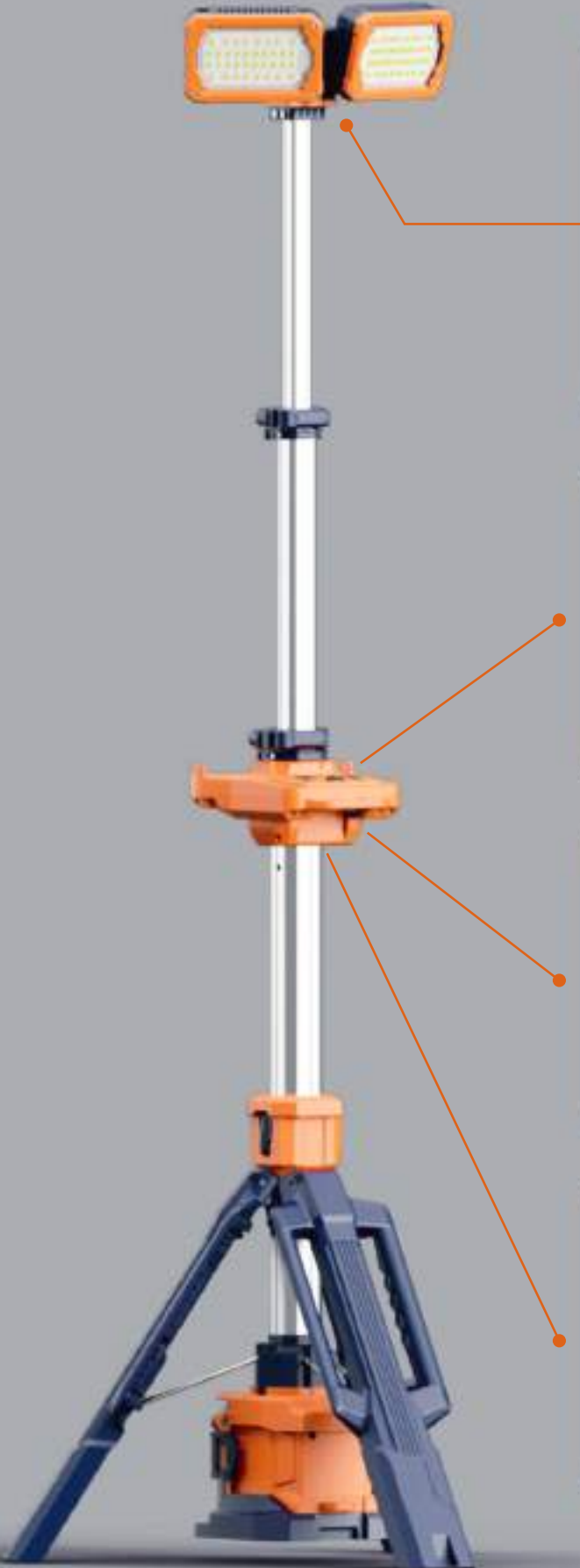

Ultra-long Endurance

Standard Mode Up To **8+** Hours
(D24-100 & Dual-head Version)



D24-54

Typical working hours 2 hours on TL-00 Eco mode.



D24-100

Doubled typical working hours to 5 hours.



▪ Dual-head

AC	0-11,000LM Stepless Dimmable	
Battery (4 Mode)	Turbo	5,000LM
	Standard	3,000LM
	Balanced	1,800LM
	Eco	500LM

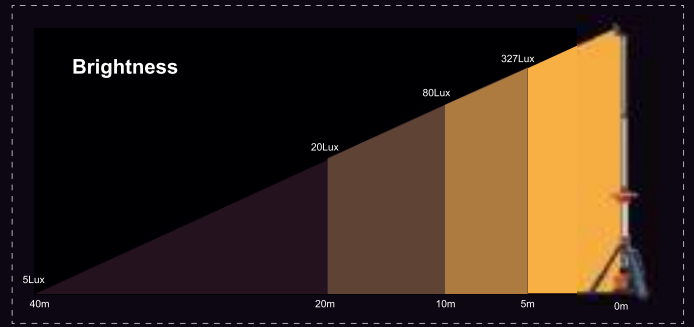

* 'Brightness' represents the center point illuminance value of the lighting direction.

▪ Single Head

Battery (4 Mode)	Turbo	3,000LM
	Standard	2,000LM
	Balanced	1,200LM
	Eco	350LM

AC Powered

Up To **11,000** LM

Battery-powered

Up To **5,000** LM





Construction



Maintenance



Infrastructure



Camping



Railway



Mining



Emergency



Sport

One person operation

Less than 6Kg exclude battery

2.3m



1.0m



Specifications

AT-200 Dual head

Hight	1m~2.3m
Weight	6.3Kg (Fitting only)
Power Supply	D24 series battery pack / AC 100-277V
Lumens	0 - 12,000Lm
Run Times	>8 hours (Standard mode, D24-100)
IP Grade	IP66
Output(USB)	5V 2A (2 Dock)

AT-200 Single head

Hight	1m~2.3m
Weight	5.9Kg (Fitting only)
Power Supply	D24 series battery pack
Lumens	0 - 4,000Lm
Run Times	>8 hours (Standard mode, D24-100)
IP Grade	IP66
Output(USB)	5V 2A (2 Dock)

Size (mm)

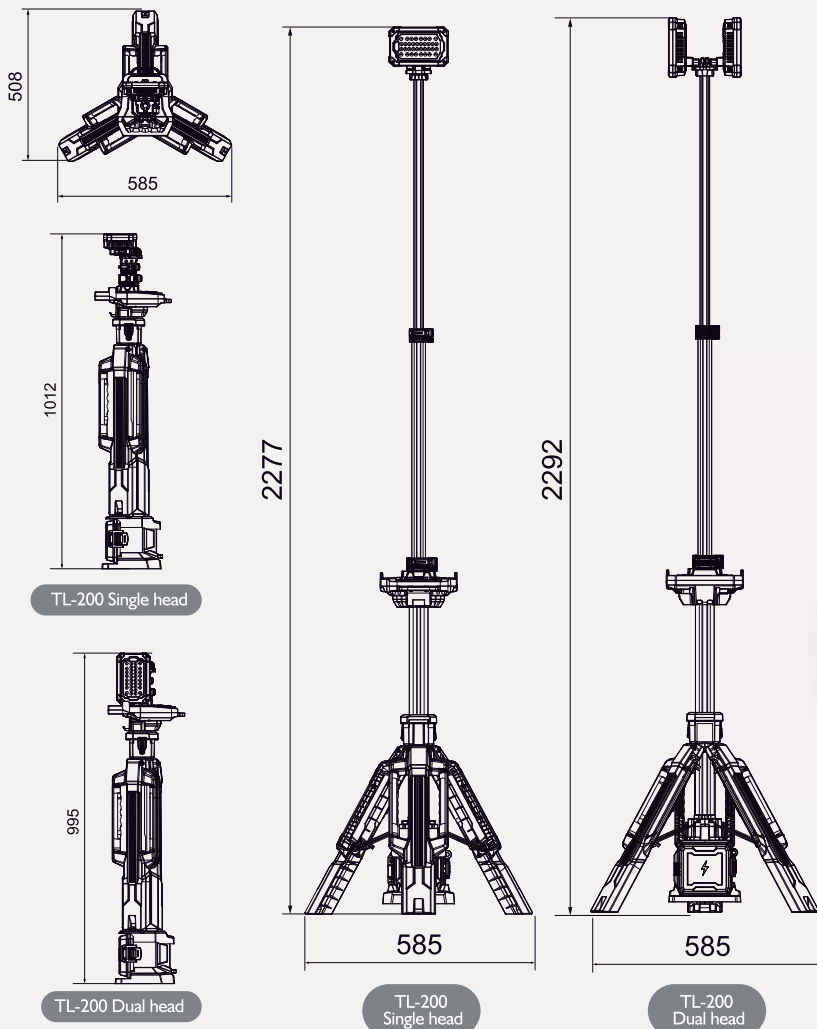

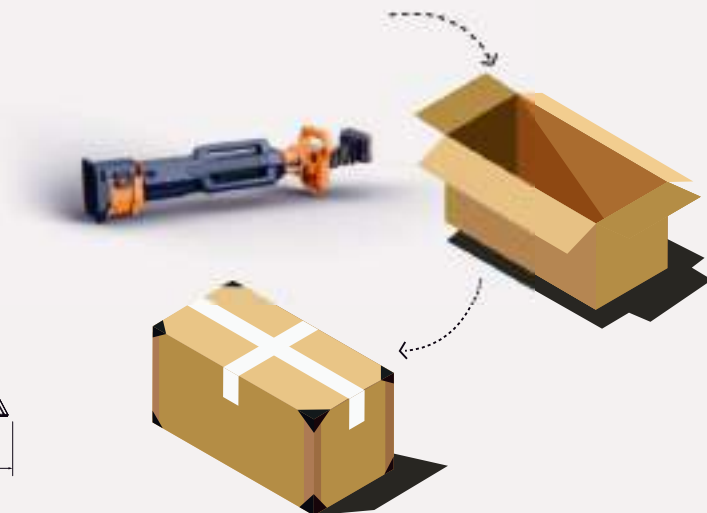

Package

Model	AT-200 Single head	AT-200 Dual head
Size of Carton	107x28x33cm	107x28x33cm
Gross Weight of Carton	7.5KG5±%	8.0KG5±%
PCS/Carton	1	1



ASCENTECH LIGHTENING SOLUTION

 +91 8130388587
  Ballabgarh, Faridabad
 www.ascentech.in
  ascentechled@gmail.com





AT-300

Deployable portable lighting in one bespoke robust package.

Portable Tripod Light



HIGHER, BRIGHTER, MORE STABLE

steps and can be completed in 10 seconds.



1 Release the legs



2 Release and rise the extension pole

Secure the lamp at any height with the buckle.



One-click release or lock of the legs.



Ground pegs are available to secure the light tower, providing wind and

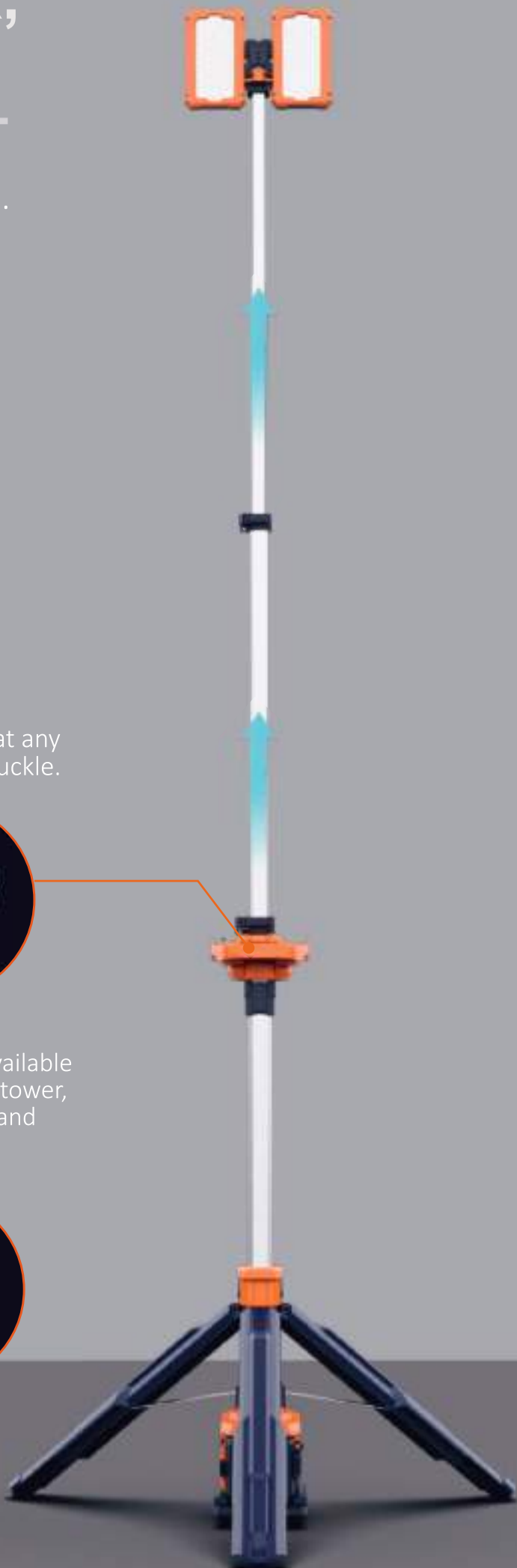

HUMANIZED DESIGN HIDDEN IN THE DETAILS

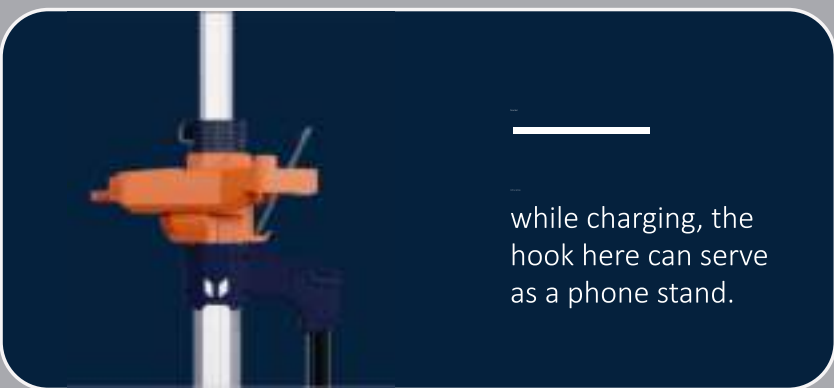

LOWER CENTER OF GRAVITY, GREATER STABILITY.

Ultra-low center of gravity combined with extended legs effortlessly handles strong winds and slopes.



Ultra-long working hours

Standard Mode Up To **13+** Hours
(D24-100 x2)



D24-54 x 2

Typical working hours 36+ hours on Eco mode.



D24-100 x 2

Doubled typical working hours to 71+ hours.



High light efficiency illuminating a wider space

AC Powered

Up To **14,000**_{LM}

Battery-powered

Up To **8,000**_{LM}

Stepless Dimmable





Construction



Emergency



Sport



Maintenance



Infrastructure



Outdoor activities

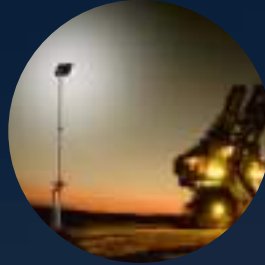

Mining



Railway

Designed for single-person operation

Easy to grip and move,
weight 8.2 kg excluding battery pack.



1.25m

3.1m



Specifications

AT-300

Height	1.25m-3.1m
Weight	8.2KG (Fitting only)
Power Supply	D24 series battery pack /AC 100-277V
Lumens	0-14000Lm
Run Times	>13h10mins (Standard mode, D24-100 x 2)
IP Grade	IP66
Output(USB)	5V 2A
Operating Temp	-10°C-50°C



Size (mm)

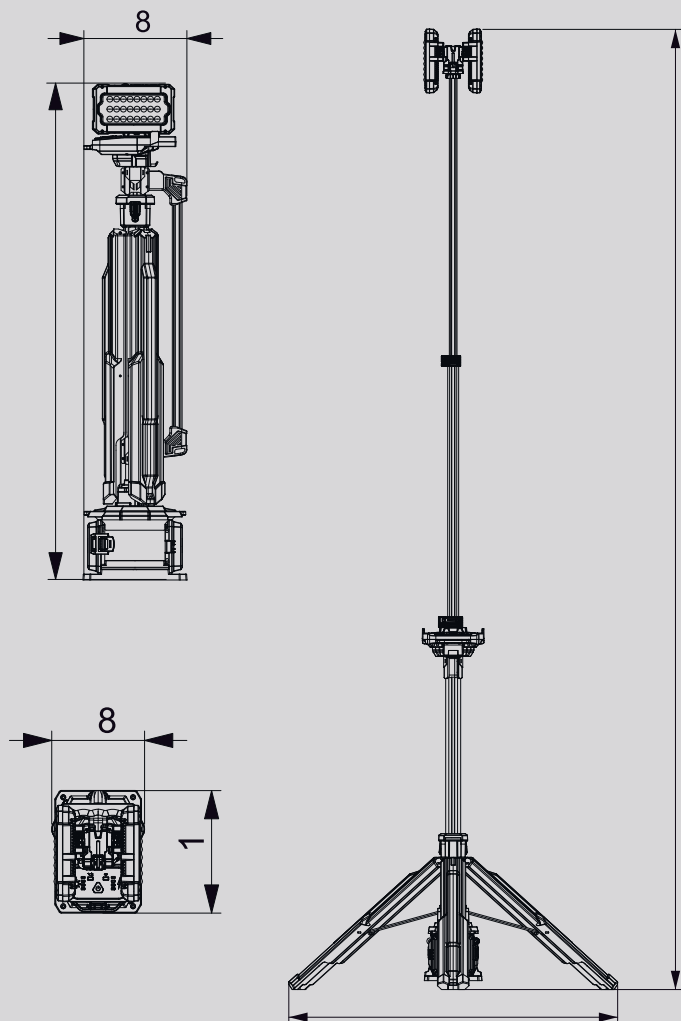

Package

Model	AT-300
Size of Carton	1350x290x380mm
Gross Weight of Carton	10.5KG
PCS/Carton	1

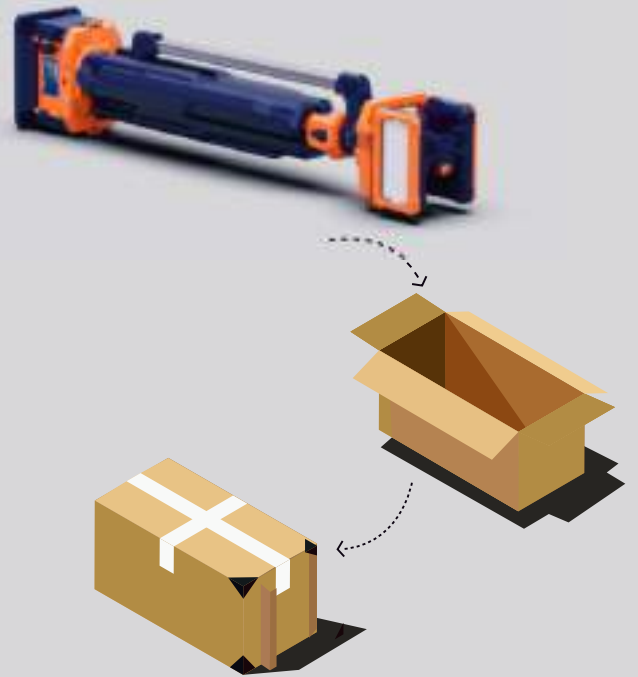

ASCENTECH LIGHTENING SOLUTION

+91 8130388587 Ballabgarh, Faridabad
www.ascentech.in ascentechled@gmail.com



The image shows two tall, black, telescopic light towers standing on a muddy construction site at night. The towers are illuminated from within, and their top sections are lit up. In the background, there are construction workers in orange safety vests, a yellow excavator, and a yellow truck. The scene is dimly lit, with the primary light source being the towers themselves.

AT-500

**SINGLE-PERSON OPERATED
BATTERY POWERED
PORTABLE LIGHT TOWER**

ASCENTECH LIGHTENING SOLUTION

+91 8130388587 Ballabgarh, Faridabad
www.ascentech.in ascentechled@gmail.com

ZERO

- NOISE
- EMISSIONS
- FUEL CONSUMPTION



0dB Quiet Operation



50Kg-Class Single-Person Rapid Deployment



0 Diesel Cost



Triple Wheel + Self-Locking Leg Adapts To All Terrains



0 Carbon Emissions



IP65 Weatherproof Wind Resistance Level 8



0 Maintenance Cost



Lithium Battery Powered Versatile For Various Sites



0 Trailer Cost



Fully Rotatable Head & Adjustable Beam Angle For Versatile Lighting Area

TL-500 cuts both equipment and life-cycle consumption / transportation / maintenance costs compared to the traditional fuel generator light tower.

COST



MOS (Months of service)



High Elongation Ratio For Easy Storage And Transport

5.3m

4.2m

1.2m

1.3m



Unique Cloud-Axis Electric Telescopic Pole

Original mechanical structure that maximizes weight reduction while maintaining stability.

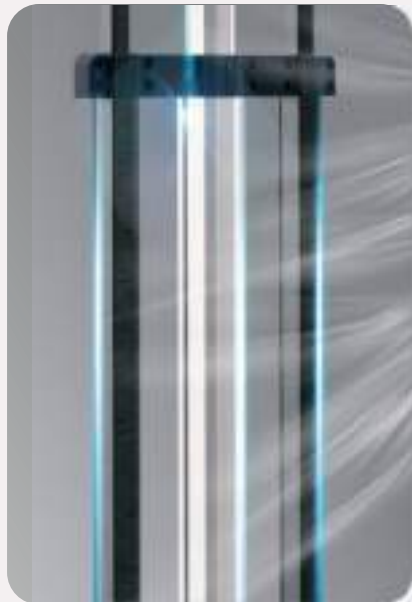

IP65, resistant to 8-level winds, corrosion-resistant, available in most climates.



Each lamp head can be adjusted freely.

Unidirectional
Multi-Point Lighting



360° Lighting with
Adjustable Coverage



**180° rotation around the
shared X-axis of the two
modules**



**360° rotation around
the X-axis**



**180° rotation
around the Y-axis**

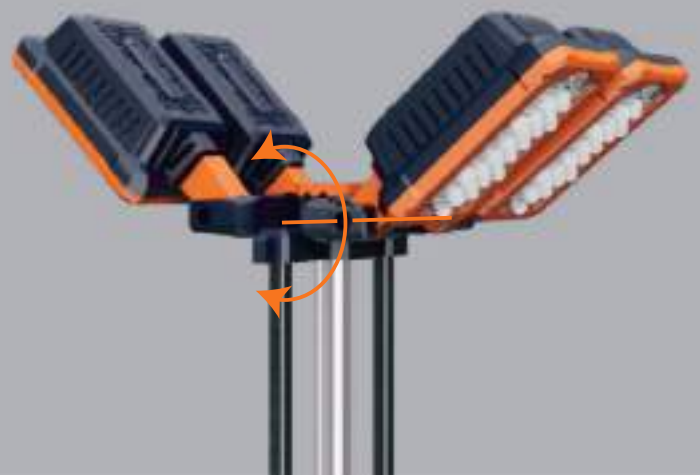

Multi-Level Self-Locking Support Legs

Adapt to all terrains, whether it is steps, slopes or potholes.



Integrated dual-axis level, easily find the balance point



Unique Coaxial 3-Wheel Design

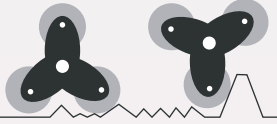

Easy one-person transport on any terrain.



Special slots are compatible with small warning lights.



A handle that provides the best grip doubles as lift point.



Climbs heights without a forklift if necessary.



Stays stable on muddy ground with maximum contact surface.

Wading depth up to 10cm refers to the water line mark on the light tower body.

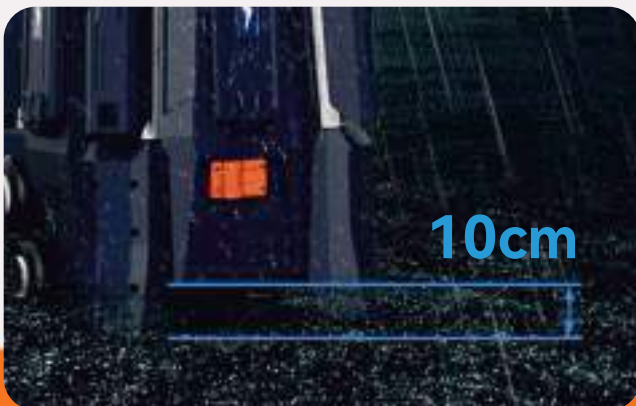

Humanized Design Hidden In The Details



Handheld controller

With spring wire, no need to bend over to operate.

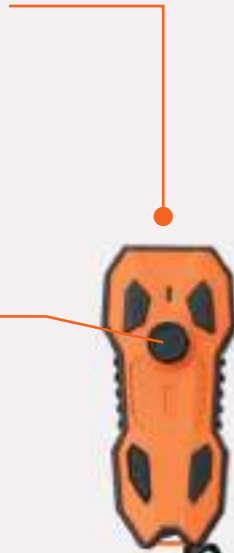
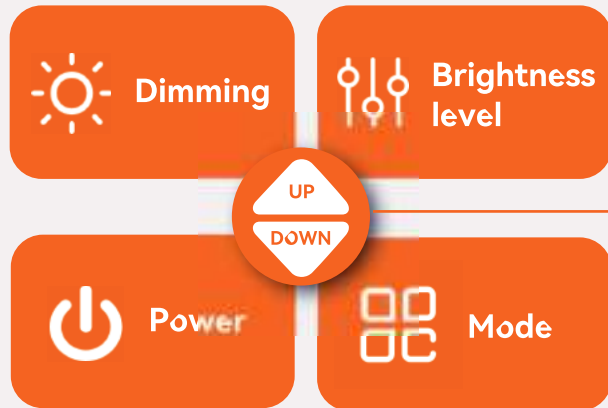

Multifunctional storage space design

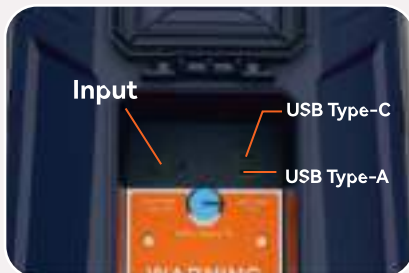

Equipped with multiple interfaces to charge devices

Waterproof toolbox

Didn't change the battery in time? Don't worry.

Disengage the clutch, then manually retract the pole.

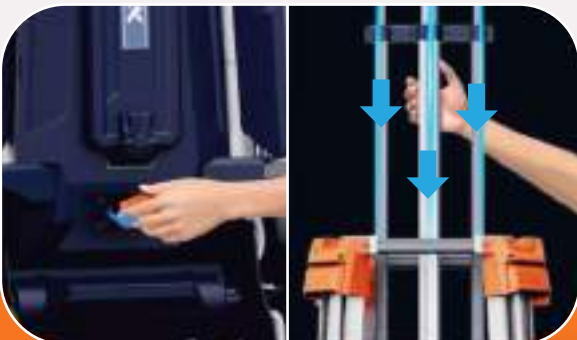

Ultra-Long Working Hours



AT24-500 (3Kg)

Portable lithium battery with large capacity in a small size



10 - 100 Hours

Turbo Mode Eco Mode

With 3 of fully charged battery power alone, it can provide 10-100 hours lighting.



X3

It also supports using an AC driver for direct power connection.



High-Efficiency LED Light Source



Free switching of multiple angles.

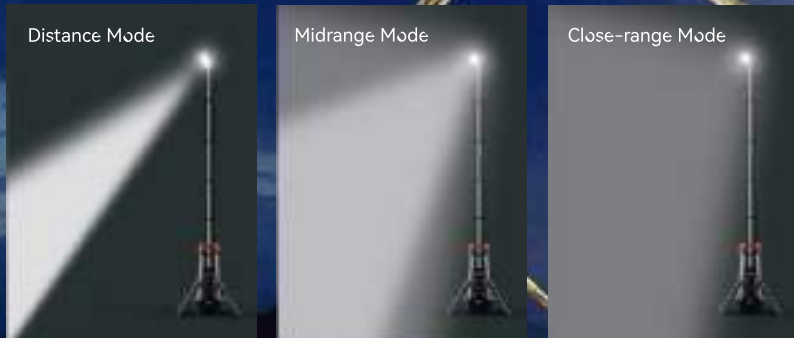

4.2M
Battery-powered
Up To **33,000LM**

5.3M
Battery-powered
Up To **35,000LM**

4 Levels of Brightness (Battery Powered)



	Eco	Balanced	Standard	Turbo
5.3M	3,000LM	10,000LM	18,000LM	35,000LM
4.2M	2,800LM	9,500LM	17,000LM	33,000LM

The brightness and battery level can be viewed on the controller when using batteries.



4.2M
AC Powered
Up To **62,000LM**

5.3M
AC Powered
Up To **65,000LM**

Stepless Dimmable (AC Powered)

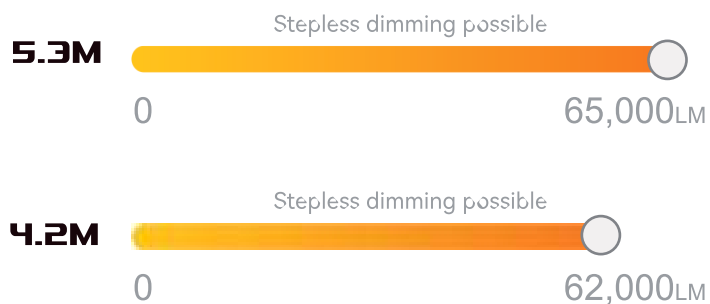

When AC powered, knob on driver controls 0-100% dimming.



Optional Accessories



A variety of accessories are available to expand the power supply options.



Charger (MC-2H)



Battery (AT24-500)



Driver - AC100-277V Input (x5-320)



AT-9H

AT8-200

9 Bay Charger Case (3x24-500 Available)
+ Solar Panel



One-Person Operation



Only one operator is needed to transport, deploy, and adjust lighting.

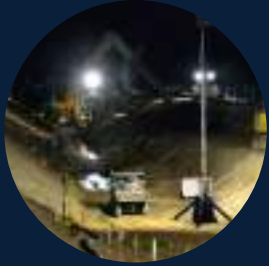

Construction



Mining

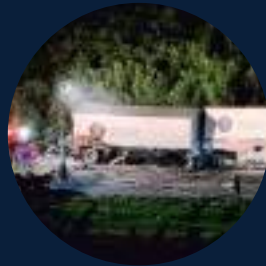

Emergency

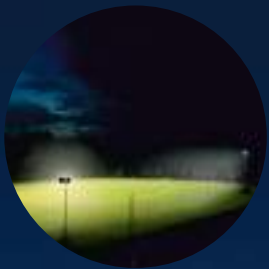

Sport



Firefighting



Event

The total light tower weight is
(excluding battery pack).

50 kg (4.2m) **52 kg** (5.3m)

For quick deployment in emergencies this equipment fits easily into standard SUVs for single-person loading. ★



★ Proper securing and part locking are crucial during transport. Two or more people are required for lifting unless a forklift is available.

Parameter



AT-500 4.2m

Height	4.2m
Weight	50Kg (Fitting only)
Power Supply	Battery / AC 100-277V
Lumens	Battery 0-33,000LM / AC 0-62,000LM
Run Times	>20h (Standard mode, D24-500 x 3)
IP Grade	IP65
Output(USB)	Type-A (5V 2A) & Type-C (5V 2A)
Battery System	D24 Series

AT-500 5.3m

Height	5.3m
Weight	52Kg (Fitting only)
Power Supply	Battery / AC 100-277V
Lumens	Battery 0-35,000LM / AC 0-65,000LM
Run Times	>20h (Standard mode, D24-500 x 3)
IP Grade	IP65
Output(USB)	Type-A (5V 2A) & Type-C (5V 2A)
Battery System	D24 Series

Size (cm)

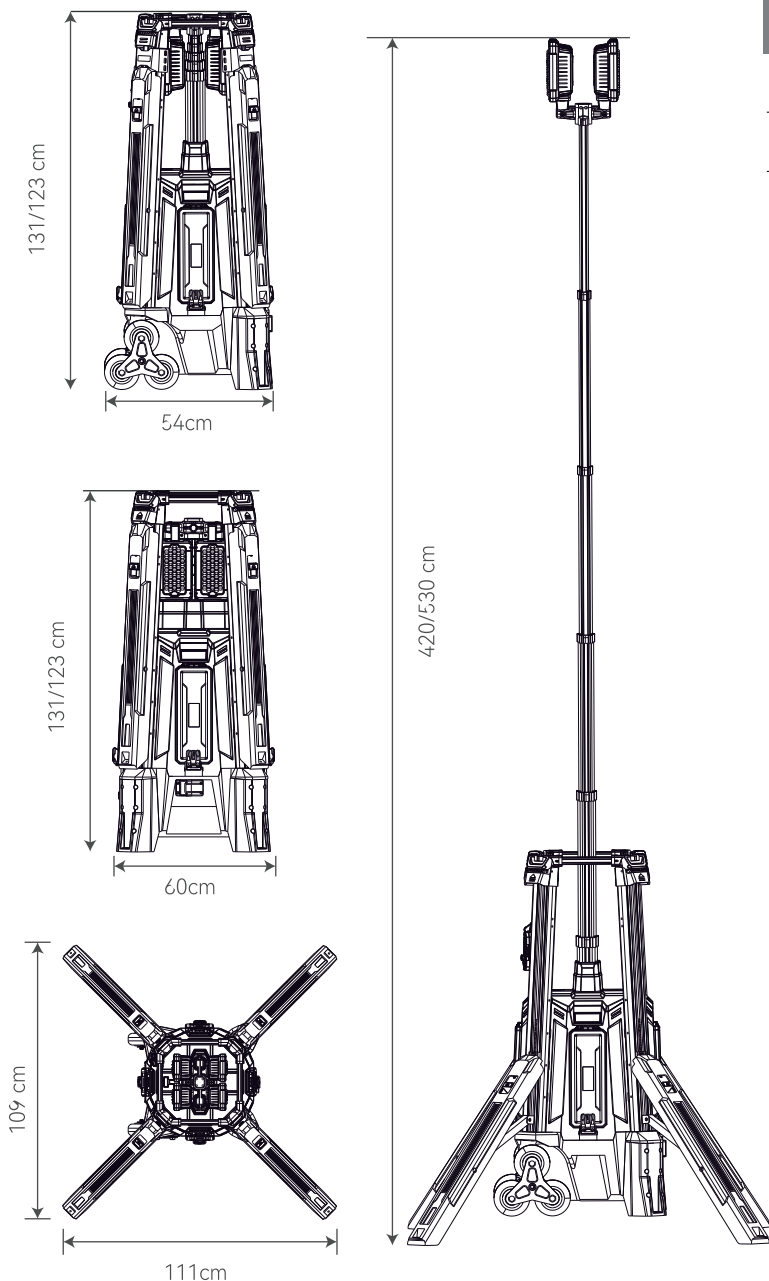

Package

Model	Size of Carton	Gross Weight of Carton	PCS/Carton
AT-500 4.2m	640*640*1365mm	63Kg	1
AT-500 5.3m	640*640*1435mm	65Kg	1

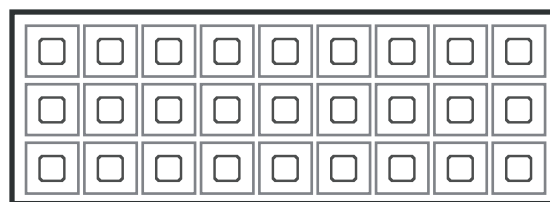
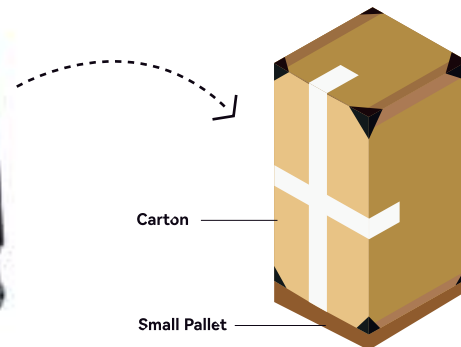

20GP Container 27 Unit



40GP Container 54 Unit